

**Controllers**

USER MANUAL

ST-292 V1-3

EN



[WWW.TECH-CONTROLLERS.COM](http://WWW.TECH-CONTROLLERS.COM)

## **I. Safety**

Before using the device for the first time the user should read the following regulations carefully. Not obeying the rules included in this manual may lead to personal injuries or controller damage. The user's manual should be stored in a safe place for further reference. In order to avoid accidents and errors it should be ensured that every person using the device has familiarized themselves with the principle of operation as well as security functions of the controller. If the device is to be sold or put in a different place, make sure that the user's manual is there with the device so that any potential user has access to essential information about the device.

The manufacturer does not accept responsibility for any injuries or damage resulting from negligence; therefore, users are obliged to take the necessary safety measures listed in this manual to protect their lives and property.



### **WARNING**

- The device should be installed by a qualified electrician.
- The regulator should not be operated by children.



### **WARNING**

- Any use other than specified by the manufacturer is forbidden.
- Before and during the heating season, the controller should be checked for condition of its cables. The user should also check if the controller is properly mounted and clean it if dusty or dirty.

### II. Description of the device

ST-292 room regulator is intended for controlling the heating device (e.g. gas, oil or electric furnace or the boiler controller). Its main task is to maintain the pre-set temperature in the flat by sending a signal to the heating device (contact opening) when the desired temperature is reached.

Advanced software enables the regulator to fulfil a wide range of functions:

- maintaining the pre-set room temperature
- manual mode
- day/night program
- weekly control

Controller equipment:

- touch buttons
- front panel made of 3mm glass
- built-in temperature sensor
- batteries

Controller versions:

- v1 – wired, without backlight.
- v2 – wireless, with temporary backlight. It may be optionally equipped with a wireless external sensor. This controller version cooperates with an additional signal receiver, installed near the heating device.
- v3 – wired, with temporary backlight.

### III. Controller installation

The controller should be installed by a qualified person.

ST-292 controller may be installed as a panel mountable on the wall.

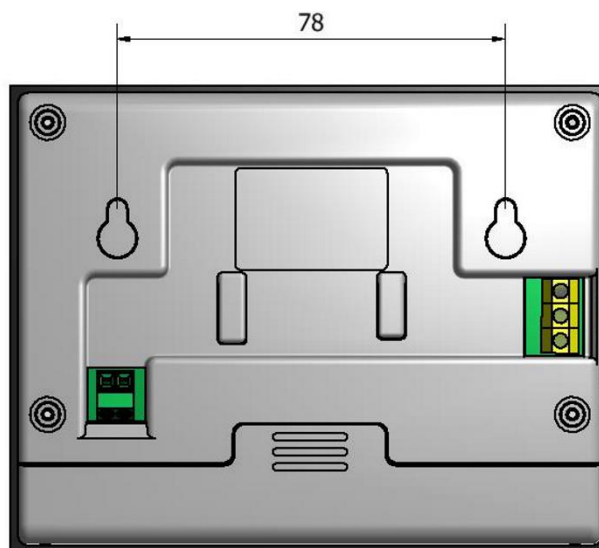

### III.a) Connection diagrams

The room regulator should be connected to the heating device via a two-core cable as illustrated in the diagrams below:

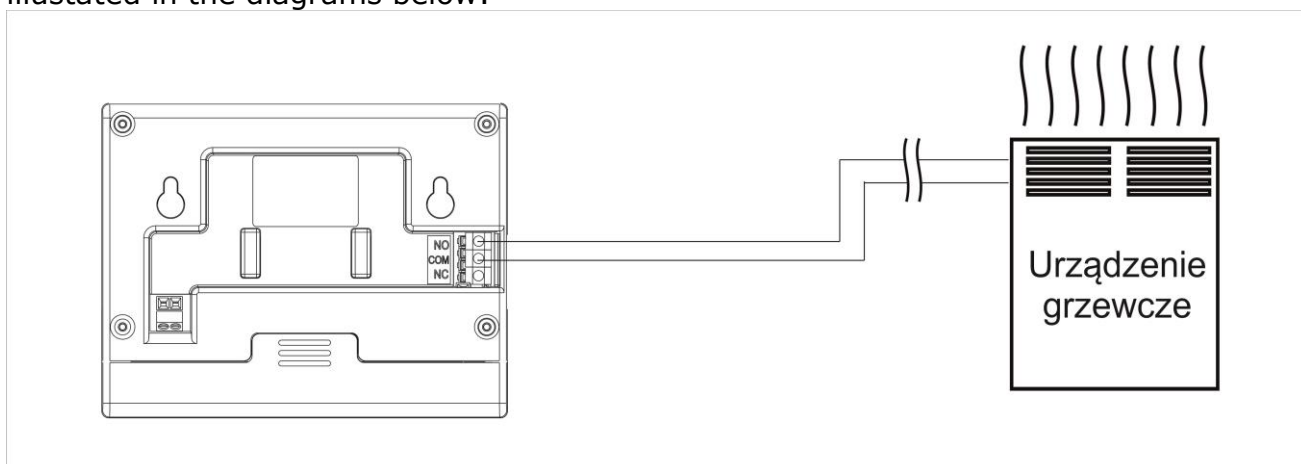

1. Diagram: ST-292 regulator connected directly to the heating device.

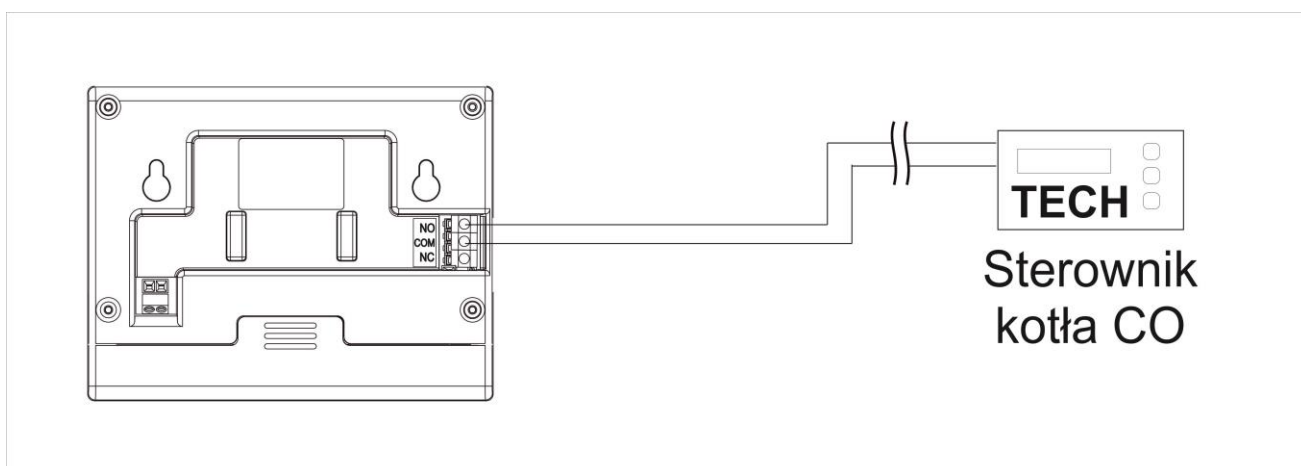

2. Diagram: ST-292 regulator connected to the CH boiler controller.

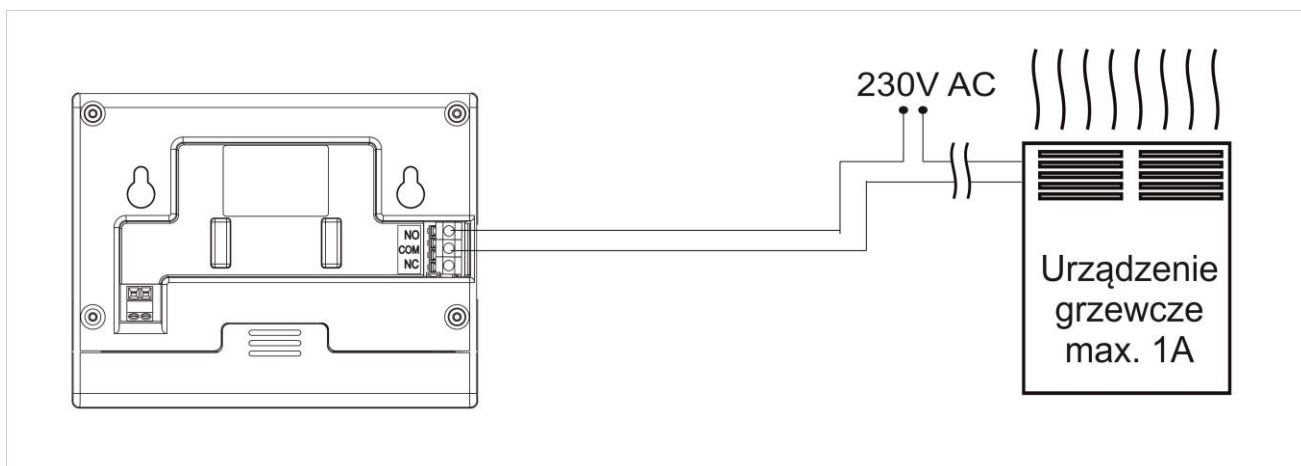

3. Diagram: ST-293 regulator connected to the heating device with load up to 1A.

# ST-292 User's manual

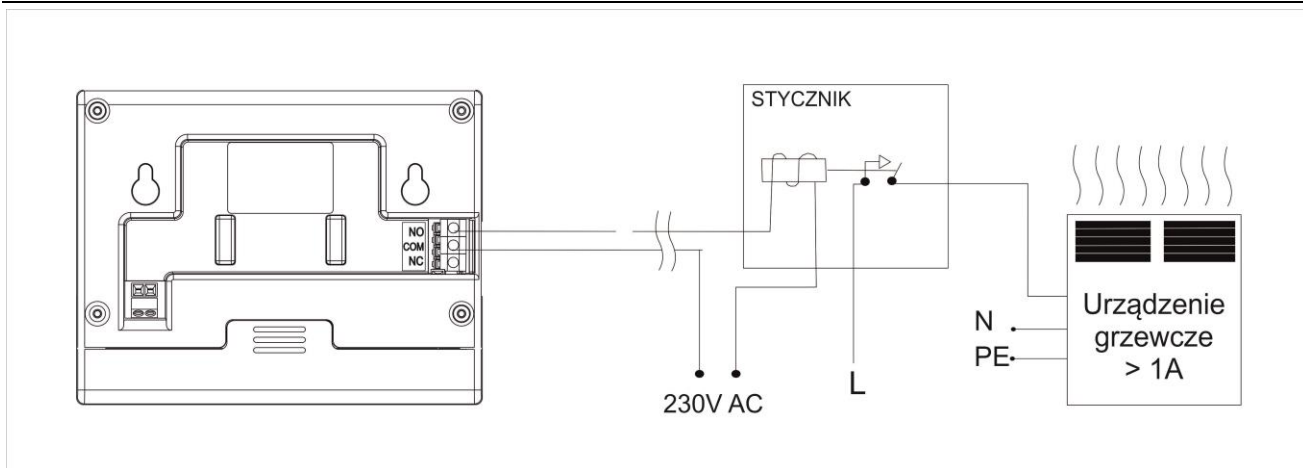

4. Diagram: ST-292 room regulator connected to the heating device with load above 1A.

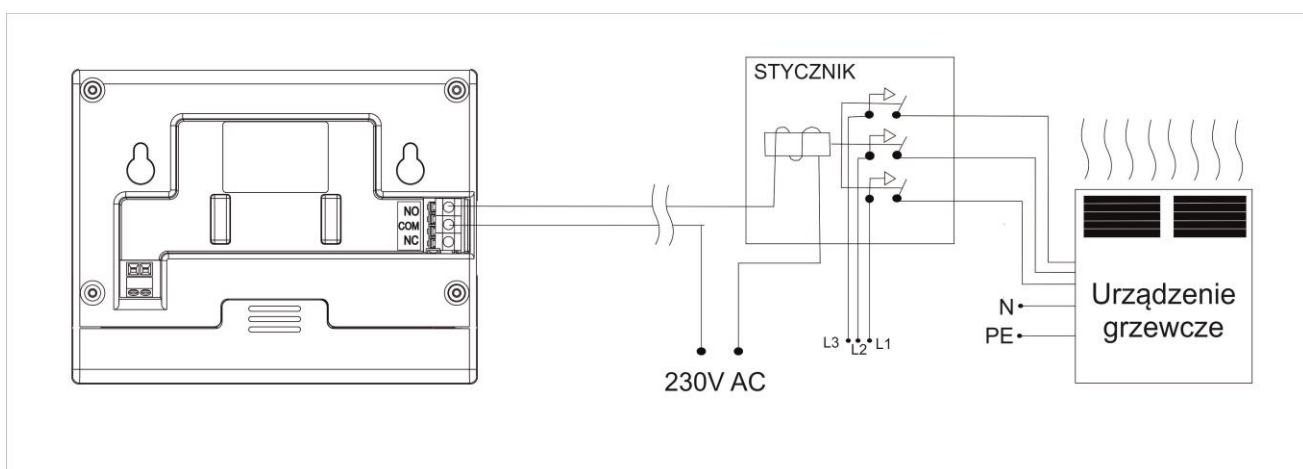

5. Diagram: ST-292 room regulator connected to a three-phase heating device.

In the case of wireless connection, the diagrams presented above should be used – the two-core communication cable should be connected to appropriate sockets in the receiver.

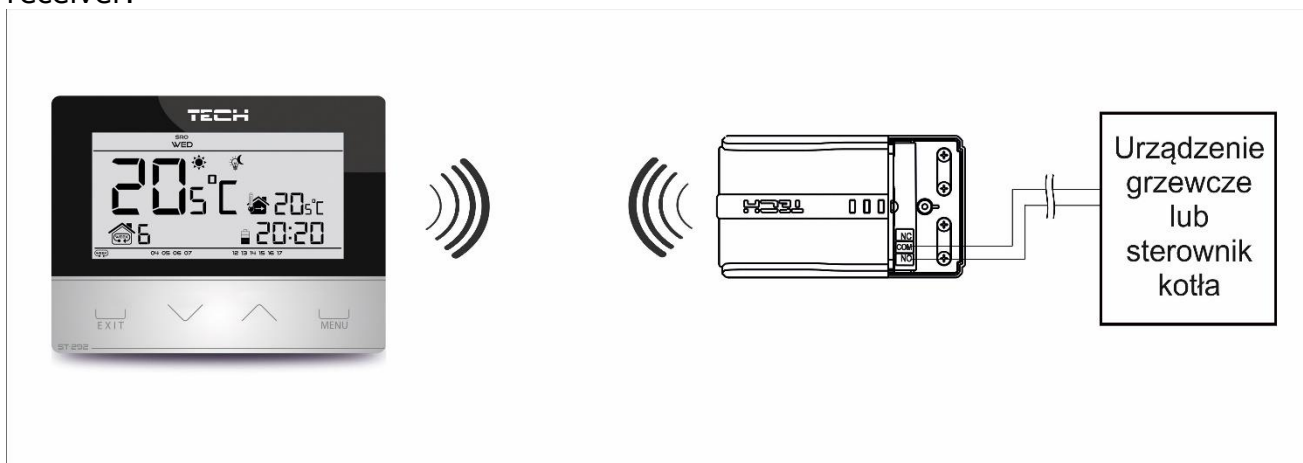

## IV. Receiver for wireless controller

ST-292v2 regulator communicates with the heating device (or the CH boiler controller) via radio signal sent to the receiver. The receiver is connected to the heating device (or CH boiler controller) via a two-core cable whereas the communication with the room regulator is performed wirelessly via radio signal.



The receiver has the following control lights:

- green 1 – indicates data reception, goes on during channel change;
- red – indicates receiver operation
- green 2 – goes on when the room temperature fails to reach the pre-set temperature – the heating device is switched on.

### How to change the communication channel

Channel "35" is the default communication channel in the room regulator. The channel may be easily changed (if the current channel is used by other devices). To change the channel, press and hold the channel change button for about 10 seconds until the green control light (1) goes on. Next, change the communication channel in the room regulator following the procedure described in part V.c.10. The green light on the receiver should go off.

## V. External temperature sensor

ST-292v2 room regulator may optionally be equipped with an external temperature sensor. The sensor should be mounted in a shaded place so that it is not affected by the weather conditions. The current temperature value will be sent to the room regulator every few minutes and it will be displayed on the main screen.

The external sensor communicates with the room regulator via radio signal. Both the room regulator and the external sensor are pre-configured to operate on channel "35", but the user may easily change the channel (if the current channel is used by other devices).



### How to change communication channel:

## ST-292 User's manual

---

In order to change the channel, press and hold the channel change button. After the control light on the sensor flashes, the process of channel change has been initiated. Hold the button and wait until the light starts flashing again. The number of flashes corresponds to the first digit of the desired channel number.

Release the button after the desired number of flashes and press it again to set the second digit of the channel number – the control light flashes quickly twice. Hold the button and wait until the light flashes the desired number of times. When the button is released, the control light flashes twice – the new communication channel has been set.

NOTE: In case of a one-digit channel number (channels 0÷9) set 0 as the first digit.

### Example 1:

28 is the desired communication channel. In order to select this channel, set the first digit - 2, and the second digit - 8.

Press and hold the channel change button - the control light flashes quickly once - the process of channel change has been initiated. Hold the button and wait until the light flashes two more times (the first digit of the channel number - 28).

Release the button and press it again - the control light flashes quickly twice - the process of setting the second digit has been initiated. Hold the button and wait until the light flashes 8 times. When the button is released, the control light flashes quickly twice - the new communication channel has been successfully set.

### Example 2:

7 is the desired communication channel. In order to select this channel, set the first digit - 0, and the second digit - 7.

Press and hold the channel change button - the control light flashes quickly once - the process of channel change has been initiated. As the first digit is 0, release the button before the control light flashes again. Press the button again - the control light flashes quickly twice - the process of setting the second digit has been initiated. Hold the button and wait until the light flashes 7 times (the second digit of the desired number). When the button is released, the control light flashes quickly twice - the new communication channel has been successfully set.

In case of errors in the channel change process, the control light goes on for ca. 2 seconds. In such a case the channel will not be changed.

## VI. First start-up

In order for the controller to operate correctly, the following steps must be followed when starting the device for the first time:

1. Insert the batteries.



### **WARNING**

While inserting new batteries the user must **not** press the touch buttons

2. Connect the regulator with the heating device via a two-core cable. In the case of ST-292v2 version, the two-core cable should be plugged into appropriate sockets in the receiver.
3. In the case of using a wireless room regulator, it is necessary to check if the current communication channel selected in the regulator is the same as in the receiver. "35" is the default communication channel in all devices. If there is a conflict with other devices using radio communication, the user needs to select a different channel.

## VII. How to use the controller

### V.a) Principle of operation

The main task of ST-292 room regulator is to maintain the pre-set temperature of the room by sending a signal to the heating device (contact opening) when the desired temperature is reached. In such a situation, the heating device is switched off (if the regulator is connected to the CH boiler controller, the CH boiler enters sustain mode).

### V.b) Operation modes

The regulator offers the following modes of operation:

- **Day/night mode**

In this mode the pre-set temperature value depends on the current time of the day. The user may set different temperature values for the daytime and nighttime (comfort temperature and economical temperature) as well as define the exact time of entering day mode and night mode.

In order to activate this mode, press EXIT button until *day/night mode* icon appears on the main screen.

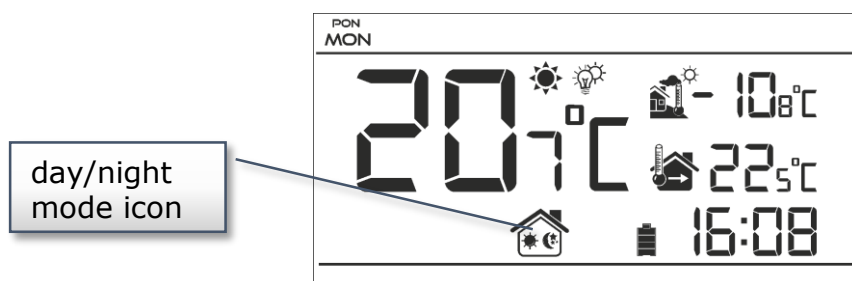

- **Weekly control**

This mode enables the user to define the time when the pre-set comfort temperature and the pre-set economical temperature will apply. The user may set 9 different programs divided into three groups:

- *programs 1÷3* – daily temperature values are set for all days of the week;
- *programs 4÷6* – daily temperature values are set separately for the weekdays (Monday-Friday) and for the weekend (Saturday-Sunday);
- *programs 7÷9* – daily temperature values are set for each day of the week separately.

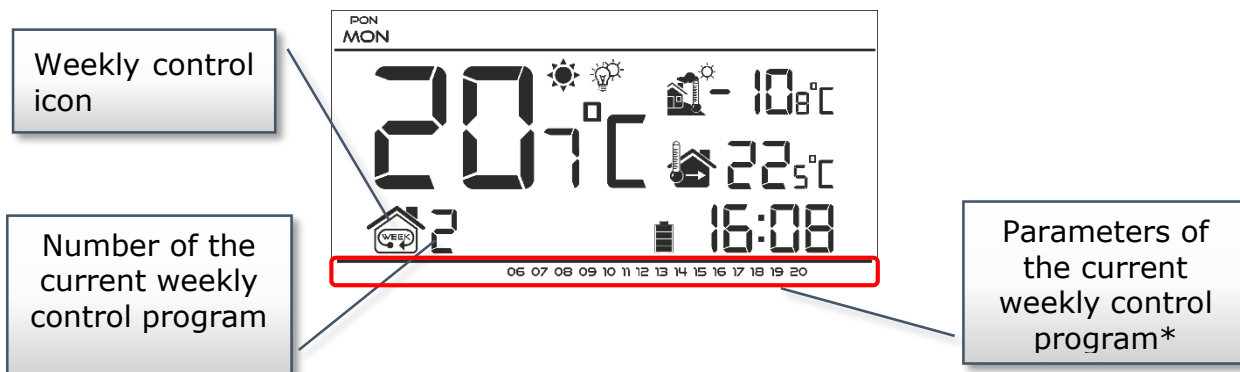

\* The display shows the hours when the comfort temperature applies. In the remaining time period economical temperature applies.



# ST-292 User's manual

- **Manual mode**

In this mode the pre-set temperature is adjusted manually from the main screen view with the use of these buttons:  $\wedge$   $\vee$  . Manual mode is activated when one of these buttons is pressed. When the manual mode is activated, the previous operation mode enters 'sleep mode' until the next pre-programmed temperature change. Manual mode may be deactivated by pressing EXIT button.

Example 1 – manual mode activation in Day/night mode

When *Day/night mode* is active, the user changes the pre-set temperature by pressing  $\vee$   $\wedge$  , which automatically activates manual mode. The controller returns to Day/night mode when daytime changes into nighttime (or the other way round) or when the user presses EXIT.

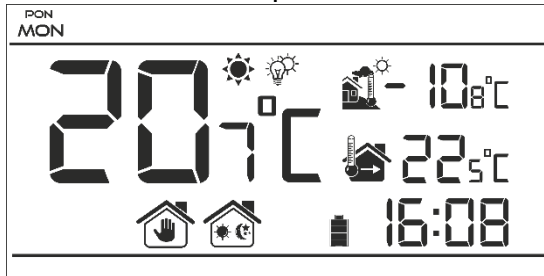

Example 2 – manual mode activation in weekly control mode

When *weekly control* is active, the user changes the pre-set temperature by pressing  $\vee$   $\wedge$  , which automatically activates manual mode. The controller returns to weekly control mode when, according to the weekly schedule, economical temperature changes into comfort temperature (or the other way round) or when the user presses EXIT.

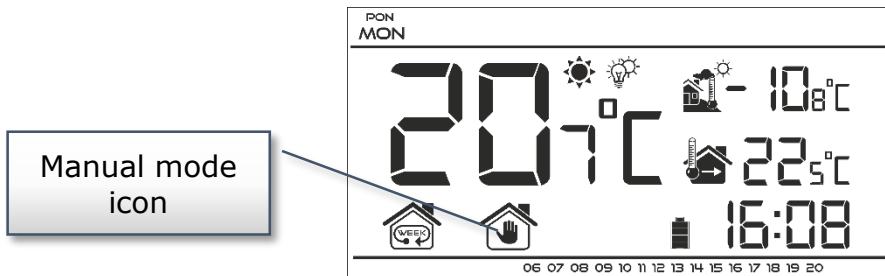





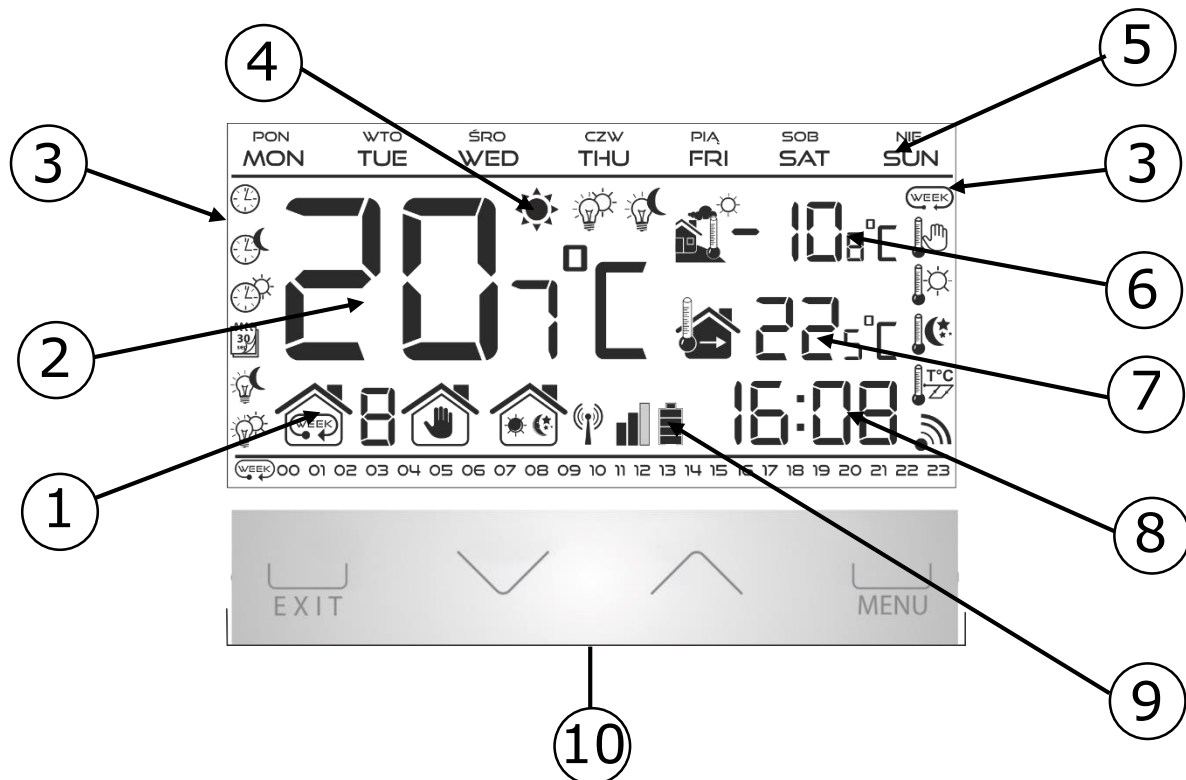





**V.b) Main screen view and description**

The user operates the device using touch buttons. While one parameter is being edited, the remaining icons are not displayed.



1. Current operation mode:
  - a. weekly
  - b. manual
  - c. day/night
2. Current temperature of the room.
3. Parameters icons.
4. Temperature information: if this icon is displayed, the pre-set temperature has been reached. If the icon is flashing, the pre-set temperature of the room has not been reached.
5. Day of the week.
6. External temperature: available only when the wireless version of the controller (ST-292v2) is used, together with the external temperature sensor ST-291.
7. Pre-set temperature of the room.
8. Time.
9. Battery level.
10. Buttons for introducing changes.

# ST-292 User's manual

Graphic icons:			
	Time settings		Weekly program selection
	Night from...		Comfort temperature
	Day from...		Economical temperature
	Weekly control settings		Hysteresis
	Pre-set economical temperature active		Channel selection
	Pre-set comfort temperature active		

## V.c) Controller functions

The user navigates the menu structure using  $\nabla$ ,  $\wedge$ , EXIT and MENU. In order to edit particular parameters, press MENU. Next, press MENU to view the controller functions – the edited parameter is flashing whereas the remaining parameters are not displayed. Use  $\nabla$ ,  $\wedge$  to change the parameter settings. Press MENU to confirm the changes and move on to edit the next parameter or press and EXIT to confirm the changes and return to the main screen view.

### V.c.1) Block diagram of the main menu

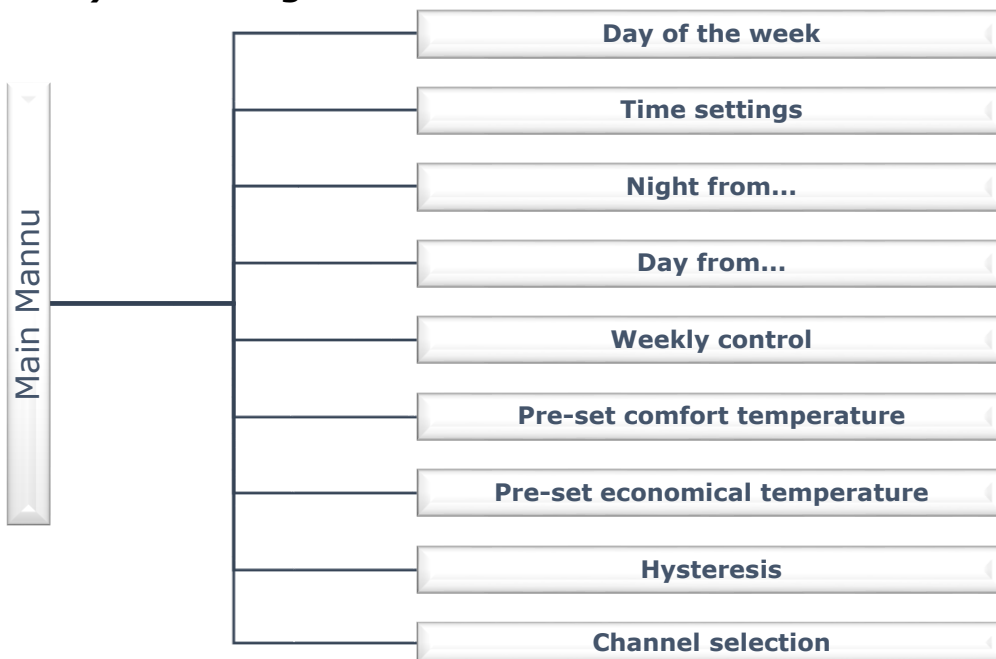

**V.c.2) Day of the week**

After entering the main menu, all icons which are not connected with the parameter which is being edited are not displayed. The first parameter is day of the week.

Press **∨** or **∧** until the current day of the week is displayed. Press MENU to confirm and move on to the next parameter or press EXIT to confirm and return to the main screen view.

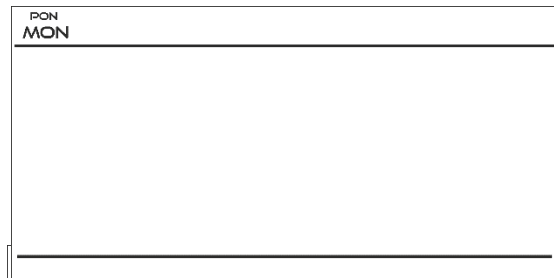

**V.c.3) Time settings**

In order to set current time, press MENU until time setting panel is displayed on the screen.

By pressing **∨** or **∧** set the hour and minutes. Press MENU to confirm and move on to the next parameter or press EXIT to confirm and return to the main screen view.



**V.c.4) Night from...**

This function enables the user to define the exact time of entering the night mode. When Day/night mode is active, economical temperature applies at nighttime.

To configure this parameter press MENU until *Night from...* setting appears on the screen.

By pressing **∨** or **∧** set the hour and minute of night mode activation.

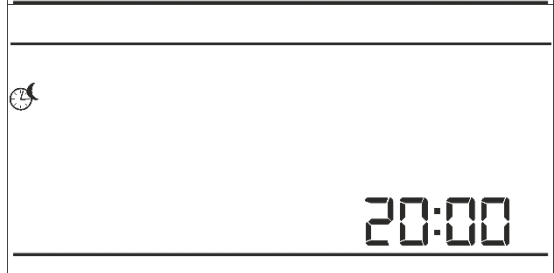

Press MENU to confirm and move on to the next parameter or press EXIT to confirm and return to the main screen view.

**V.c.5) Day from...**

This function enables the user to define the exact time of entering the day mode. When Day/night mode is active, comfort temperature applies at daytime.

To configure this parameter press MENU until *Day from...* setting appears on the screen.

By pressing **∨** or **∧** set the hour and minute of day mode activation.

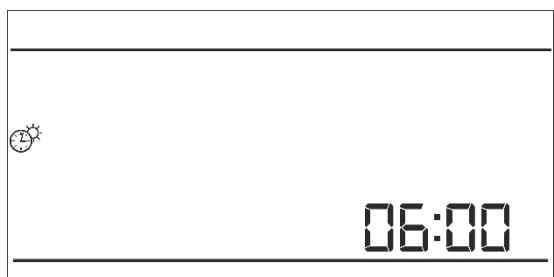

Press MENU to confirm and move on to the next parameter or EXIT to confirm and return to the main screen view.

**V.c.6) Weekly program**

This function is used to change the current weekly control program and edit the weekly programs.

**• How to change the current weekly program number**

When weekly control is enabled (see: V.b Operation modes) the current program is activated. In order to choose the program number, press MENU until *weekly program* setting appears on the screen.

By pressing and holding MENU button the user opens the program selection panel. Each time the user holds the MENU button, the program number

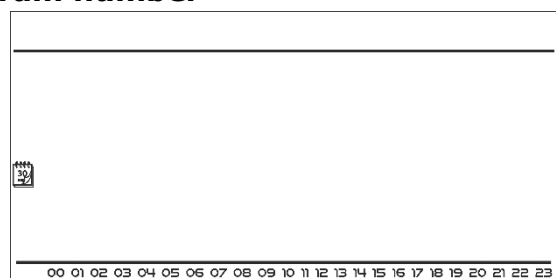

## ST-292 User's manual

changes. When the desired number appears on the screen, press MENU – the controller returns to the main screen view and the selected program number is set.

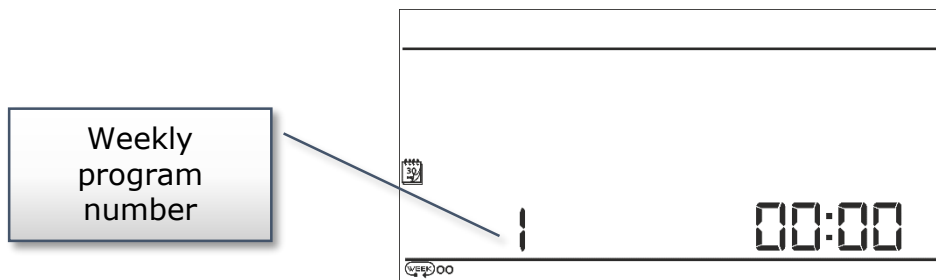

- **How to configure particular weekly programs**

Weekly program allows the user to define the time when comfort temperature and economical temperature will apply. Depending on the program number, the user may set daily temperature values for all days of the week (programs 1÷3), for weekdays and the weekend separately (programs 4÷6) and for each day of the week separately (programs 7÷9).

In order to edit weekly program, press MENU until weekly program setting panel appears on the screen.

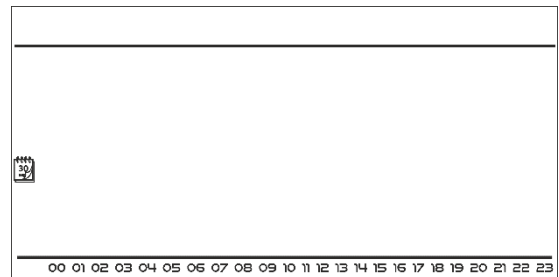

### STEP 1 – choose the program to be edited:

By pressing and holding MENU button the user opens the program editing panel. Each time the user holds the MENU button, the program number changes. When the desired number appears on the screen, the user may start editing its parameters.

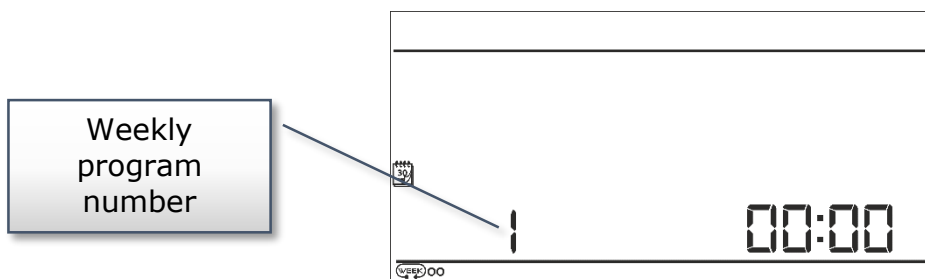

### Step 2 – Select days of the week

If the user wants to edit programs 1÷3, there is no possibility of selecting particular days of the week as the setting applies to each day.

If the user wants to edit programs 4÷6, it is possible to edit the settings for weekdays and the weekend separately. Press MENU in order to select.

Editing weekdays parameters

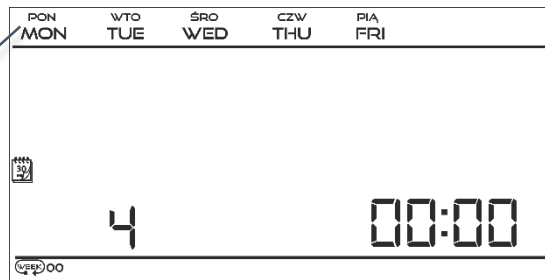

If the user wants to edit programs 7÷9, it is possible to edit the settings for each day separately. Press MENU in order to select a day.

Editing parameters for Monday

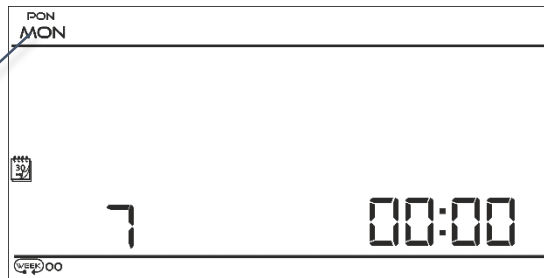

Step 3 – assign comfort temperature or economical temperature to particular hours  
 An hour which is being edited is displayed on the controller screen. In order to assign comfort temperature, press  $\wedge$ . In order to select economical temperature, press  $\vee$ . The controller automatically moves on to editing the next hour.

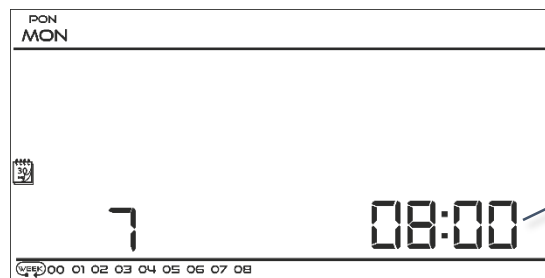

Edited hour

The parameters of the weekly program are displayed at the bottom of the screen: hours to which comfort temperature has been assigned are displayed whereas hours to which economical temperature has been assigned are not displayed.

Example:

The following screenshot presents daily settings of program no. 7 for Monday

- 24<sup>00</sup>-01<sup>59</sup>- economical temperature
- 02<sup>00</sup>-06<sup>59</sup>- comfort temperature
- 07<sup>00</sup>-14<sup>59</sup>- economical temperature
- 15<sup>00</sup>-21<sup>59</sup>- comfort temperature
- 22<sup>00</sup>-00<sup>59</sup>- economical temperature

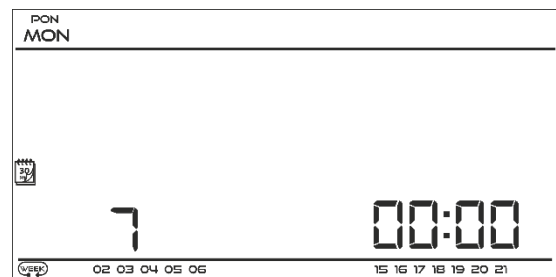

**NOTE**

When the user finishes the editing process by pressing EXIT button, the controller returns to the main screen view and this program is selected as the current program.

## ST-292 User's manual

### V.c.7) Pre-set comfort temperature

Pre-set comfort temperature is used in weekly control mode and day/night mode. Press MENU button until the comfort temperature change panel appears on the screen.

Press  $\nabla$  or  $\blacktriangle$  to set the desired temperature.

Press MENU to confirm and move on to the next parameter or press EXIT to confirm and return to the main screen view.



### V.c.8) Pre-set economical temperature

Pre-set economical temperature is used in weekly control mode and day/night mode. Press MENU button until the economical temperature change panel appears on the screen.

Press  $\nabla$  or  $\blacktriangle$  to set the desired temperature.

Press MENU to confirm and move on to the next parameter or press EXIT to confirm and return to the main screen view.

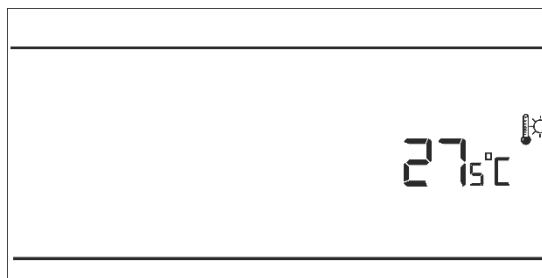

### V.c.9) Pre-set temperature hysteresis

Room temperature hysteresis defines the pre-set temperature tolerance in order to prevent undesired oscillation in case of small temperature fluctuation (within the range of  $0,2 \div 4^{\circ}\text{C}$ ).

#### Example:

Pre-set temperature :  $23^{\circ}\text{C}$

Hysteresis :  $1^{\circ}\text{C}$

The room regulator reports that the temperature is too low only when the room temperature drops to  $22^{\circ}\text{C}$ .

In order to set the hysteresis, press MENU until the hysteresis setting appears on the screen.

Use  $\nabla$  or  $\blacktriangle$  to set the desired hysteresis value.

Press MENU to confirm and move on to the next parameter or press EXIT to confirm and return to the main screen view.

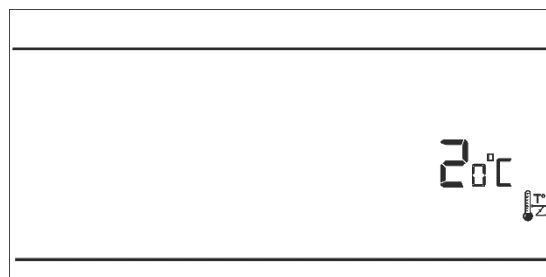

### V.c.10) Selecting wireless communication channel (ST-292v2)

ST-292v2 regulator communicates with the heating device or the CH boiler controller using radio waves (via the receiver). In order to ensure effective communication, the same channel needs to be selected in both the controller and the receiver (in the case of using an external sensor, it is necessary to set the same communication channel in this device as well). "35" is the default channel in all devices. The channel must be changed only if there is a conflict with other devices using radio communication.



In order to change the channel, press MENU until the communication channel change panel appears on the screen.

Use  $\nabla$  or  $\blacktriangle$  to set the desired channel.

Press MENU and hold it for ca. 3 seconds to confirm and return to the main screen view or press EXIT to confirm and return to the main screen view.

## VIII. Technical data

Range of room temperature setting	5°C : 35°C
Supply voltage	Batteries 2xAA, 1,5V
Accuracy of measurement	+/- 1°C
Contact load	1A/230V/50Hz
Operating temperature	5°C : 50°C
Dimensions	120x94x24 mm



*Care for the natural environment is our priority. Being aware of the fact that we manufacture electronic devices obligates us to dispose of used elements and electronic equipment in a manner which is safe for nature. As a result, the company has received a registry number assigned by the Main Inspector of Environmental Protection. The symbol of a crossed out rubbish bin on a product means that the product must not be thrown out to ordinary waste bins. By segregating waste intended for recycling, we help protect the natural environment. It is the user's responsibility to transfer waste electrical and electronic equipment to the selected collection point for recycling of waste generated from electronic and electrical equipment.*



# ST-292 User's manual

---

## Contents

I. Safety .....	2
II. Description of the device .....	3
III. Controller installation.....	3
III.a) Connection diagrams .....	4
IV. Receiver for wireless controller.....	6
V. External temperature sensor.....	6
VI. First start-up .....	7
VII. How to use the controller .....	8
V.a) Principle of operation .....	8
V.b) Operation modes .....	8
V.b) Main screen view and description .....	10
V.c) Controller functions .....	11
V.c.1) Block diagram of the main menu .....	11
V.c.2) Day of the week .....	12
V.c.3) Time settings .....	12
V.c.4) Night from.....	12
V.c.5) Day from.....	12
V.c.6) Weekly program .....	12
V.c.7) Pre-set comfort temperature .....	15
V.c.8) Pre-set economical temperature .....	15
V.c.9) Pre-set temperature hysteresis.....	15
V.c.10) Selecting wireless communication channel (ST-292v2) .....	15
VIII. Technical data.....	16

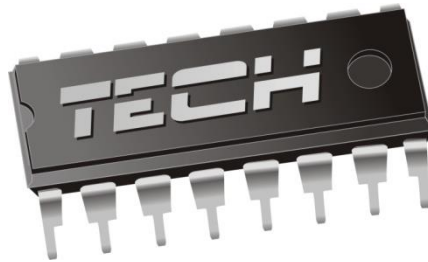

## Declaration of conformity no. 123/2013

Hereby, we declare under our sole responsibility that **ST-292 230V, 50Hz** controller manufactured by TECH, headquartered in Wieprz 1047A, 34-122 Wieprz, is compliant with the Regulation by the Ministry of Economy (Journal of Laws 155 Item 1089) of August 21, 2007 implementing provisions of the Low Voltage Directive (**LVD**) **2006/95/EC** of January 16, 2007.

**ST-292 controller has been tested for electromagnetic compatibility (EMC) with optimal loads applied.**

For compliance assessment, harmonized standards were used:

**PN-EN 60730-2-9:2011, PN-EN 60730-1:2012**

Date of **CE** marking: 05/ 2013

 <b>PAWEŁ JURA</b>	 <b>JANUSZ MASTER</b>
<small>WŁAŚCICIELE TECH SP.J.</small>	



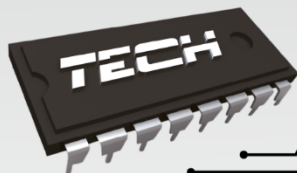

**Controllers**

**TECH Sp.j.**

*Wieprz 1047A*

*34-122 Wieprz*

**SERWIS**

**32-652 Bulowice,**

**Skotnica 120**

**Tel. +48 33 8759380, +48 33 3300018**

**+48 33 8751920, +48 33 8704700**

**Fax. +48 33 8454547**

**serwis@techsterowniki.pl**

---

**Monday - Friday**

**7:00 - 16:00**

**Saturday**

**9:00 - 12:00**

**WWW.TECH-CONTROLLERS.COM**