

Air to Water Heat Pump

Installation manual

Mono Outdoor Unit AE***BXYDEG / AE***BXYDGG

- Thank you for purchasing this Samsung Product.
- Before operating this unit, please read this installation manual carefully and retain it for future reference.



SAMSUNG

Contents

Safety precautions	3
Product specifications	5
Outdoor unit specification	6
Application examples	7
Main components	9
Functional diagram	12
Installing the unit	13
Piping work	25
Wiring	33
Testing operations	41
Setting outdoor unit option switch and key function	43
Error codes	45
Maintenance	48
Charging refrigerant	51
Troubleshooting	52
Commissioning	55
Recommissioning instructions	55



***Correct Disposal of This Product
(Waste Electrical & Electronic Equipment)***

(Applicable in countries with separate collection systems)

This marking on the product, accessories or literature indicates that the product and its electronic accessories (e.g. charger, headset, USB cable) should not be disposed of with other household waste at the end of their working life. To prevent possible harm to the environment or human health from uncontrolled waste disposal, please separate these items from other types of waste and recycle them responsibly to promote the sustainable reuse of material resources.

Household users should contact either the retailer where they purchased this product, or their local government office, for details of where and how they can take these items for environmentally safe recycling.

Business users should contact their supplier and check the terms and conditions of the purchase contract. This product and its electronic accessories should not be mixed with other commercial wastes for disposal.

For information on Samsung's environmental commitments and product-specific regulatory obligations, e.g. REACH, visit: www.samsung.com/uk/aboutsamsung/sustainability/environment/our-commitment/data/

Safety precautions

Carefully follow the precautions listed as below because they are essential to guarantee the safety of SAMSUNG product.



WARNING

- Always disconnect a power supply of Air-Water Heat Pump before servicing it or accessing components inside the unit.
- Verify that installation and testing operations shall be performed by qualified personnel.
- To prevent serious damage on the system and injuries to users, precautions and other notices shall be observed.

Warning

- ▶ Carefully read the content of this manual before installing the air to water heat pump and store the manual in a safe place in order to be able to use it as reference after installation.
- ▶ For maximum safety, installers should always carefully read the following warnings.
- ▶ Store the provided manual in a safe location with end user after installation, and remember to hand it over to the new owner if the Heat pump unit is sold or transferred.
- ▶ This manual explains how to install Air-Water Heat Pump. The use of other types of units with different control systems may damage the units and invalidate the warranty. The manufacturer shall not be responsible for damages arising from the use of non compliant units.
- ▶ The manufacturer shall not be responsible for damage originating from unauthorized changes or the improper connection of electric and hydraulic lines. Failure to comply with these instructions or to comply with the requirements set forth in the "Operating limits" table, included in the manual, shall immediately invalidate the warranty.
- ▶ Failure to comply with these instructions or to comply with the requirement on the Operating Range (Heat: -30~43°C/ Cool: 10~46°C) set forth in the Product Specification (p.5) shall immediately invalidate the warranty.
- ▶ Do not use the units if you see some damages on the units and recognize something bad such as loud noisy, smell of burning.
- ▶ In order to prevent electric shocks, fires or injuries, always stop the unit, disable the protection switch and contact SAMSUNG's technical support if the unit produces smoke, if the power cable is hot or damaged or if the unit is very noisy.
- ▶ Always remember to inspect the unit, electric connections, refrigerant tubes and protections regularly. These operations shall be performed by qualified personnel only.
- ▶ The unit contains moving parts and electrical parts, which should always be kept out of the reach of children.
- ▶ Do not attempt to repair, move, alter or reinstall the unit by unauthorized personnel, these operations may cause product damage, electric shocks and fires.
- ▶ Do not place containers with liquids or other objects on the unit.
- ▶ All the materials used for the manufacture and packaging of the air to water heat pump are recyclable.
- ▶ The packing material and exhaust batteries of the remote controller(optional) must be disposed of in accordance with local regulations.
- ▶ The air to water heat pump contains a refrigerant that has to be disposed of as special waste. At the end of its life cycle, the heat pump must be disposed of in authorized centers or returned to the retailer so that it can be disposed of correctly and safely.
- ▶ Wear protective gloves to unpack, move, install, and service the unit to avoid your hands being injured by the edge of the parts.
- ▶ Do not touch the internal parts (water pipes, refrigerant pipes, heat exchangers, etc) while running the units. And if you need to adjust and touch the units, have enough time for the unit can be cooled and be sure to wear protective gloves.
- ▶ In case of refrigerant leakage, try to avoid getting in contact with the refrigerant because this could result in severe wounds.
- ▶ When you install the Air to water heat pump in a small room, you must consider a proper ventilation to prevent a leakage level within the maximum permissible limit.
 - In that case, you may die from suffocation by some possibility.

Safety precautions

- ▶ Make sure to safely dispose of packing materials. Packing materials, such as nails and other metal or wooden pallets may cause children get injured.
- ▶ Inspect the product shipped and check if damaged during transport. If the product has some damages, DO NOT INSTALL and immediately discuss about the damages with the carrier or retailer (if the installer or the authorized technician has collected the material from the retailer.)
- ▶ Our units shall be installed in compliance with the spaces described in the installation manual, to ensure accessibility from both sides and allow repairs or maintenance operations to be carried out. If the units installed without complying with procedures described in manual, additional expenses can be asked because special harnesses, ladders, scaffolding or any other elevation system for repair service will NOT be considered part of the warranty and will be charged to the end customer.
- ▶ Always make sure that the power supply is compliant with local safety standards.
- ▶ Verify that the voltage and frequency of the power supply comply with the specifications and input power is sufficient to ensure the operation of any other domestic appliance connected to the same electric lines. Always verify that the cut-off and protection switches are suitably selected.
- ▶ Always verify that electric connections (cable entry, section of leads, protections...) are compliant with the electric specifications and with the instructions provided in the wiring scheme. Always verify that all connections comply with the standards applicable to the installation of air to water heat pumps. Devices disconnected from the power supply should be completely disconnected in the condition of overvoltage category.
- ▶ Do not connect the earth wire to the gas pipe or water pipe, lighting rod, surge absorber, or telephone earth wire. If earthing is not complete, it may cause an electric shock or fire.
- ▶ Be sure to install both an earth leakage detector and circuit breaker with specified capacity in accordance with relevant local and national regulations.
 - If it is not installed properly, it may cause electric shocks and fire.
- ▶ Make sure that the condensed water runs well out of the unit at low ambient temperature. Drain pipe and cond heater can frost/ice can not grow. If drain work is not effective for releasing condensed water, it can make the units get damaged by massive ice and system can be stop, covered by ice.
- ▶ Install the power cable and communication cable of the indoor and outdoor unit at least 1m away from the electric appliance.
- ▶ Protect the unit from rats or small animals. If an animal makes a contact with the electric parts, it can cause malfunctions, smoke or fire. Please instruct the customer to keep the area around the unit clean.
- ▶ Do not disassemble and alter the heater at your own discretion.
- ▶ Wear protective equipment (such as safety gloves, goggles, and headgear) during installation and maintenance works. Installation/repair technicians may be injured if protective equipment is not properly equipped.
- ▶ This appliance is not intended for use by persons (including children) with reduced physical, sensory or mental capabilities, or lack of experience and knowledge, unless they have been given supervision or instruction concerning use of the appliance by a person responsible for their safety. Children should be supervised to ensure that they do not play with the appliance.
- ▶ **For use in Europe:** This appliance can be used by children aged from 8 years and above and persons with reduced physical, sensory or mental capabilities or lack of experience and knowledge if they have been given supervision or instruction concerning use of the appliance in a safe way and understand the hazards involved. Children shall not play with the appliance. Cleaning and user maintenance shall not be made by children without supervision.
- ▶ Be sure not to perform power cable modification, extension wiring, and multiple wire connection.
 - It may cause electric shock or fire due to poor connection, poor insulation, or current limit override.
 - When extension wiring is required due to power line damage, refer to "How to connect your extended power cables" in the installation manual.
- ▶ Do not use means to accelerate the defrost operation or to clean, other than those recommended by Samsung.
- ▶ Do not pierce or burn.
- ▶ Be aware that refrigerants may not contain an odour.



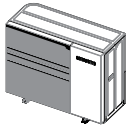
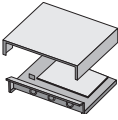

Product specifications

Product line-up

Line-up			Remark
Heat pump units	Chassis		-
	Model name	AE080BXYDEG AE080BXYDGG AE120BXYDEG AE120BXYDGG AE140BXYDEG AE140BXYDGG	
Auxiliary parts	 Control kit	MIM-E03CN MIM-E03EN	Requisite

Accessories

- ▶ Keep supplied accessories until the installation is finished.
- ▶ Hand the installation manual over to the customer after finishing installation.
- ▶ The quantities are indicated in parentheses.

Installation manual (2)	Drain plug (1)	Rubber Leg (4)
		
Shut Off Valve (1) IN (inc. Filter)	Shut Off Valve (1) OUT	
		

Outdoor unit specification

Type	Unit	AE080BXYDEG	AE120BXYDEG	AE140BXYDEG
Power source	-	1Φ, 220~240VAC 50Hz	1Φ, 220~240VAC 50Hz	1Φ, 220~240VAC 50Hz
Refrigerant	g	2,700 (R-32)	3,300 (R-32)	3,300 (R-32)
Noise (Heat/Cool, Pressure)	dB(A)	42/42	46/46	47/47
Water connection (In/Out)	Inch	1.0	1.0	1.0
Leaving water temperature	°C	Heating : 15 ~ 70 Cooling : 5~25	Heating : 15 ~ 70 Cooling : 5~25	Heating : 15 ~ 70 Cooling : 5~25
Operating range (Heat/Cool)	°C	-30~43/10~46	-30~43/10~46	-30~43/10~46
Weight (net/gross)	kg	126/146	137/157	137/157
Size (WxHxD, net)	mm	1,270 x 1018 x 530	1,270 x 1018 x 530	1,270 x 1018 x 530

Type	Unit	AE080BXYDGG	AE120BXYDGG	AE140BXYDGG
Power source	-	3Φ, 380~415VAC 50Hz	3Φ, 380~415VAC 50Hz	3Φ, 380~415VAC 50Hz
Refrigerant	g	2,700 (R-32)	3,300 (R-32)	3,300 (R-32)
Noise (Heat/Cool, Pressure)	dB(A)	42/42	46/46	47/47
Water connection (In/Out)	Inch	1.0	1.0	1.0
Leaving water temperature	°C	Heating : 15 ~ 70 Cooling : 5~25	Heating : 15 ~ 70 Cooling : 5~25	Heating : 15 ~ 70 Cooling : 5~25
Operating range (Heat/Cool)	°C	-30~43/10~46	-30~43/10~46	-30~43/10~46
Weight (net/gross)	kg	126/146	137/157	137/157
Size (WxHxD, net)	mm	1,270 x 1018 x 530	1,270 x 1018 x 530	1,270 x 1018 x 530

Application examples



- The application examples given below are for illustration purposes only.
- When the SAMSUNG Air-to-Water Heat Pump system is used in series with another heat source (e.g. gas boiler), ensure that the return water temperature not exceed 70°C.
- The unit is only to be used in a closed water system. Application in an open water circuit can lead to excessive corrosion of the water piping.
- SAMSUNG can not be held responsible for incorrect or unsafe situations in the water system. Make sure that the boiler, radiators, convectors, solar collectors, UFHs, FCUs, additional pumps, pipings, and controls in the water system are in accordance with relevant local laws and regulations under the installer's responsibility.
- By-pass valve shall be installed for space heating loops. When one of loops or all loops are closed, water flow rate could be insufficient. To keep standard flow rate and prevent flow stop, the by-pass valve shall be installed between supply collector and return collector.
- SAMSUNG shall not be held liable for damage as a result of not complying with this rule.
- SAMSUNG does not provide specific water system components such as: Pressure relief valves, Air vent valves, buffer tanks, etc. Installers and end-users shall consider how to install the above designated components in overall water system depending on the installation conditions. If the components are not installed in the appropriate location, the water system can not be operated as designed.

Application #1

Mono outdoor + Control kit

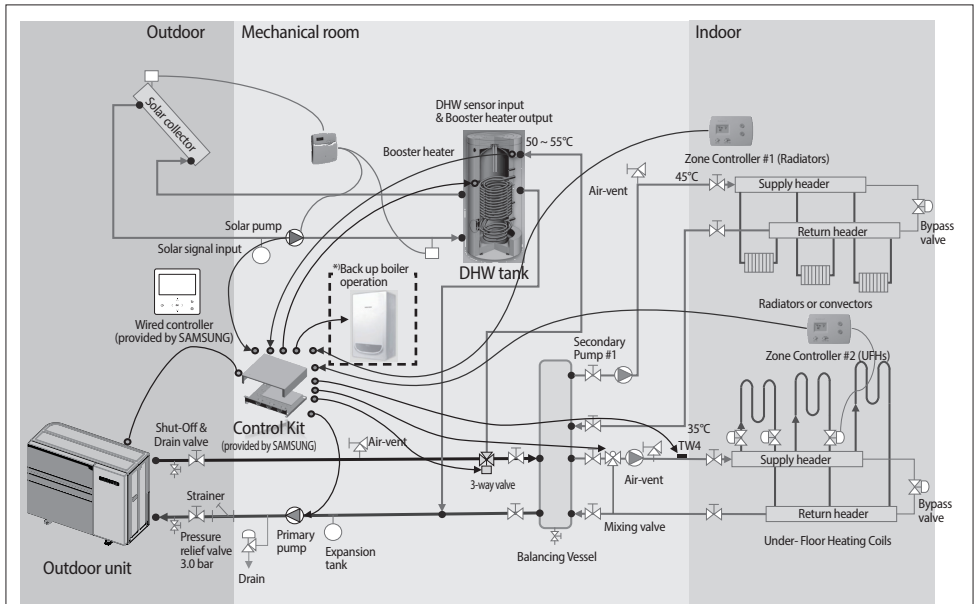

*) We control only the on / off signal of the backup boiler according to the outdoor temperature. Backup boiler should be installed with it's own control devices (thermostat and mixing valve according to the site conditions).



- Samsung is not responsible for performance and stability of the backup boiler.

Application examples

Application #2

Mono outdoor + Tank Integrated Hydro Unit

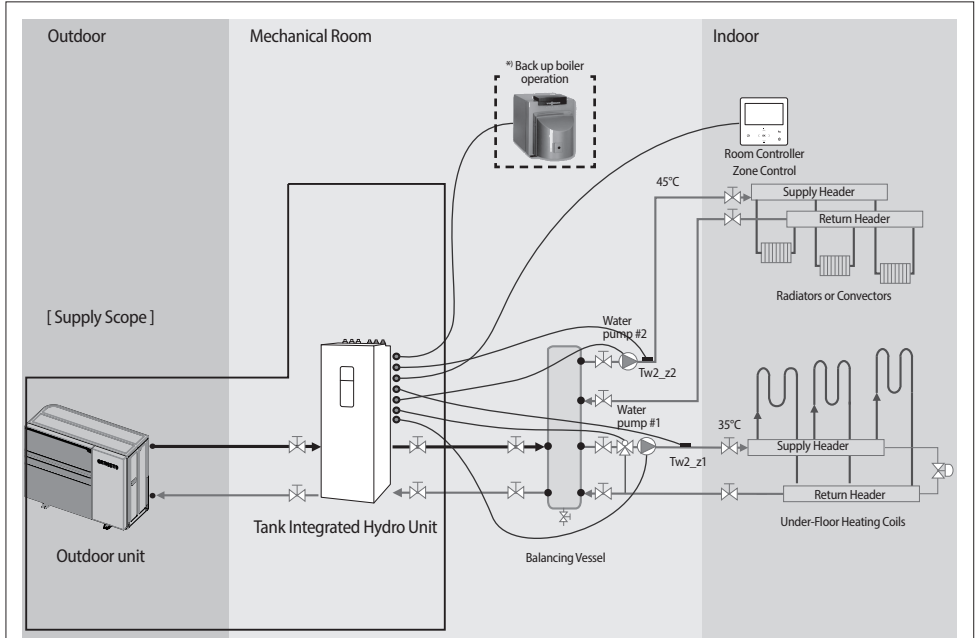

*) We control only the on / off signal of backup boiler according to outdoor temperature.
Backup boiler should be installed with own device according to the field condition.



• Samsung has not responsible for performance and stability of backup boiler.

Main components

Dimensions(Overall)

Heat pump for R-32.

- ▶ AE080BXYD** / AE120BXYD** / AE140BXYD**

(Unit : mm)

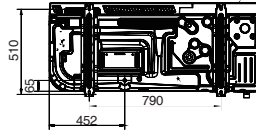
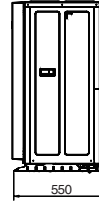
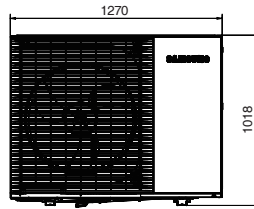
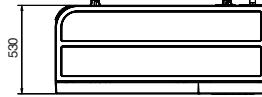
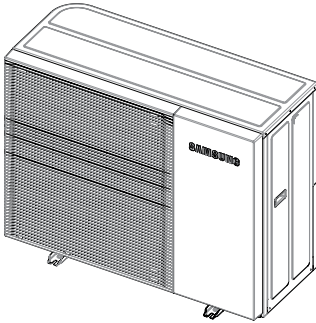

Dimensions (Water pipe)

- ▶ AE080BXYD** / AE120BXYD** / AE140BXYD**

(Unit : mm)

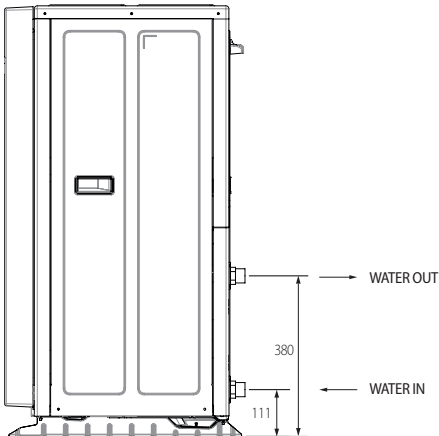

Main components

AE080BXD**

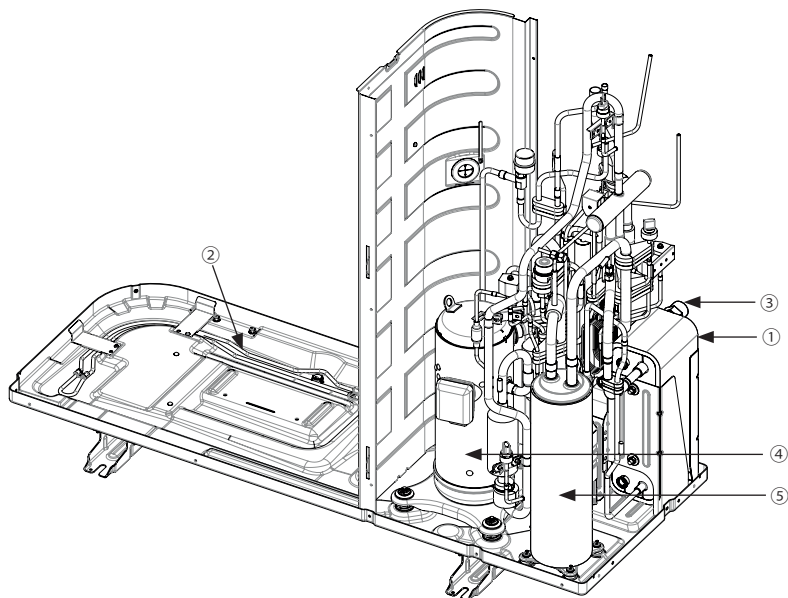

NO.	Name	Note.
①	PHE	Danfoss, B3-030 series
②	Base heater	SUS316L, 150W
③	Water fitting	BSP 1" Male
④	Compressor	Scroll type
⑤	Acumulator	2.8 liter

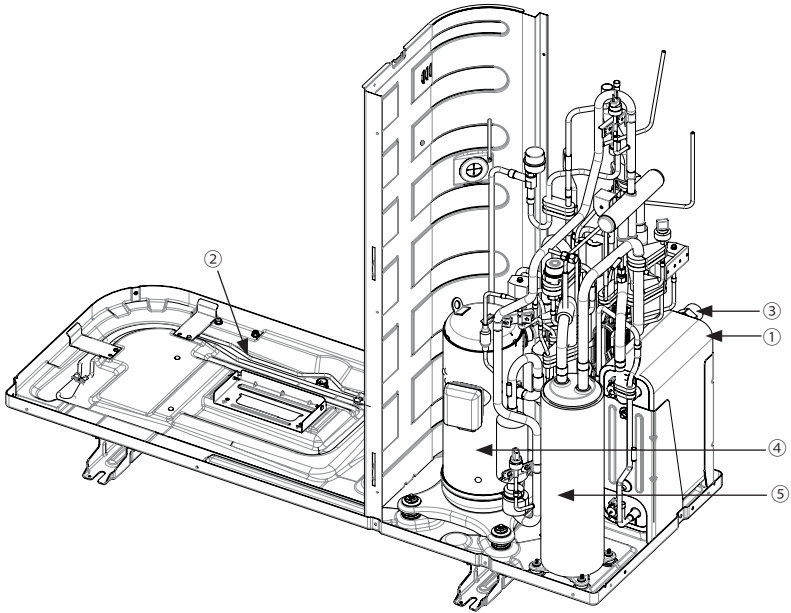

NO.	Name	Note.
①	PHE	Danfoss, B3-030 series
②	Base heater	SUS316L, 150W
③	Water fitting	BSPP 1"Male
④	Compressor	Scroll type
⑤	Acucumulator	2.8 liter

Functional diagram

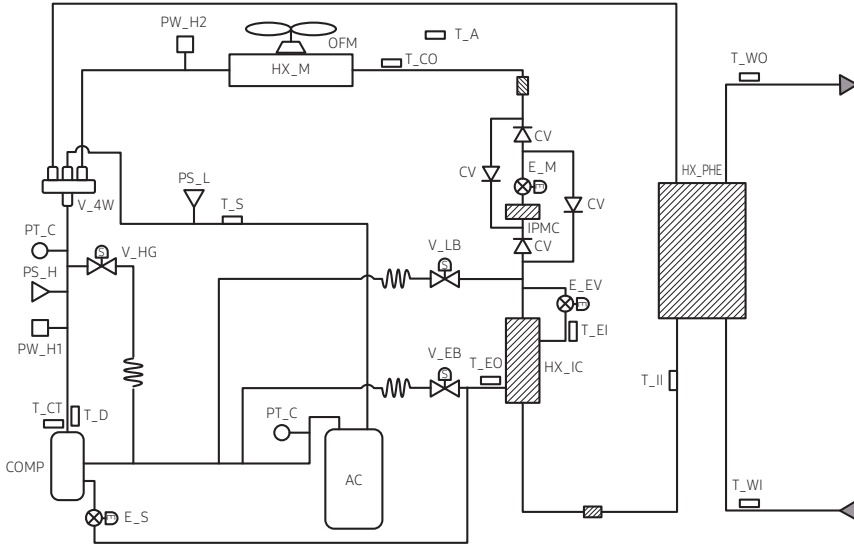

Part	Description
CV	Check Valve
COMP	Compressor
HX_IC	Heat Exchanger - Intercooler
HX_M	Heat Exchanger - Main (Outdoor unit)
HX_PHE	Heat Exchanger - PHE
IPMC	IPM Cooler
OFM	Outdoor Fan Motor
AC	Accumulator
PS_H	Pressure Sensor - High
PS_L	Pressure Sensor - Low
PW_H1	Pressure Switch - High 1
PW_H2	Pressure Switch - High 2
E_EV	Electronic Expansion Valve - EVI
E_M	Electronic Expansion Valve - Main
E_S	Electronic Expansion Valve-Shut off

Part	Description
PT_C	Service Port - Charging
V_4W	Solenoid valve - 4 Way
V_EB	Solenoid valve - EVI Bypass
V_HG	Solenoid valve - Hot Gas Bypass
T_LB	Solenoid valve - Liquid Bypass
T_A	Thermistor - Ambient
T_CO	Thermistor - Cond Out
T_CT	Thermistor - Compressor Top
T_D	Thermistor - Discharge pipe
T_EI	Thermistor - EVI In
T_EO	Thermistor - EVI Out
T_II	Thermistor - Heat Exchanger In
T_S	Thermistor - Suction pipe
T_WI	Thermistor - Water In
T_WO	Thermistor - Water Out

Installing the unit

Moving the outdoor unit

- ▶ Select the moving route in advance.
- ▶ Be sure that moving route is safe from weight of the outdoor unit.
- ▶ Do not slant the product more than 30° when carrying it. (do not lay the product down sideways)
- ▶ The surface of the heat exchanger is sharp. Be carefule not to be injured while moving and installing.

Moving the outdoor unit by wire rope

- ▶ Fasten the outdoor unit by longer wire ropes as shown at the figure.

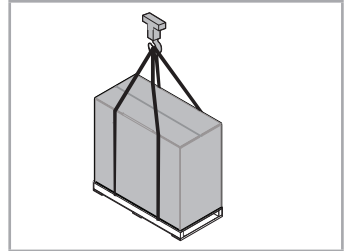

Moving the outdoor unit with a fork lift

- ▶ Insert the fork into the wooden pallet at the bottom of the outdoor unit carefully. Be careful that the fork does not damage the outdoor unit.

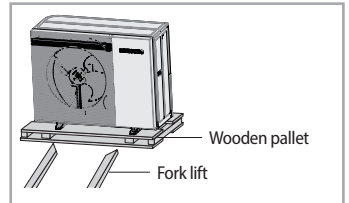

The Center of weight of the product

- ▶ When you look at the product from the front, there is a center of gravity on the right. Refer to the center of gravity mark attached to the product.

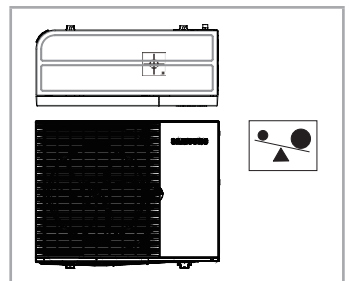

Installing the unit

Deciding on where to install the outdoor unit

Decide the installation location regarding the following condition and obtain the user's approval.

- ▶ The outdoor unit must not be placed on its side or upside down, as the compressor lubrication oil will run into the cooling circuit and seriously damage the unit.
- ▶ Choose a location that is dry and sunny, but not exposed to direct sunlight or strong winds.
- ▶ Do not block any passageways or thoroughfares.
- ▶ Choose a location where the noise of the Air to Water Heat Pump when running and the discharged air do not disturb any neighbours.
- ▶ Choose a position that enables the pipes and cables to be easily connected to the other hydraulic system.
- ▶ Install the outdoor unit on a flat, stable surface that can support its weight and does not generate any unnecessary noise and vibration.
- ▶ Position the outdoor unit so that the air flow directly stream towards the open area.
- ▶ Place the outdoor unit where there are no plants and animals because they may cause malfunction of outdoor unit.
- ▶ Maintain sufficient clearance around the outdoor unit, especially from a radio, computer, stereo system, etc.

Installation Guide at the seashore

Make sure to follow below guides when installing at the seashore.

1. Do not install the product in a place where it is directly exposed to sea water and sea breeze.
 - Make sure to install the product behind a structure (such as building) that can block sea breeze.
 - Even when it is inevitable to install the product at the seashore, make sure that the product is not directly exposed to sea breeze by installing a protection wall.
 2. Consider that the salt particles clinging to the external panels should be sufficiently washed out.
 3. Because the residual water at the bottom of the outdoor unit significantly promotes corrosion, make sure that the slope does not disturb drainage.
 - Keep the unit level so that rain does not accumulate.
 - Be careful not to block the drain hole due to foreign substance
 4. When the product is installed at the seashore, periodically clean it with water to remove accumulated salt deposits.
 5. Make sure to install the product in a place that provides smooth water drainage. Especially, ensure that the base part has good drainage.
 6. If the product is damaged during the installation or maintenance, make sure to repair it.
 7. Check the condition of the product periodically.
 - Check the installation site every 3 months and perform anti-corrosion treatment such as R-Pro supplied by SAMSUNG (Code : MOK-220SA) or commercial water repellent grease and wax, etc., based on the product condition.
 - When the product is to be shut down for a long period of time, such as off-peak hours, take appropriate measures like covering the product.
 8. If the product installed within 500m of seashore, special anti-corrosion treatment is required.
- * Please contact your local SAMSUNG representative for further details.

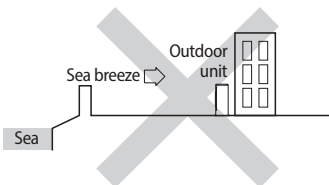

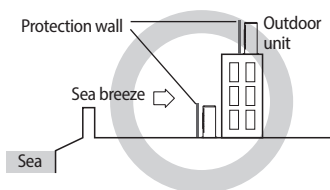
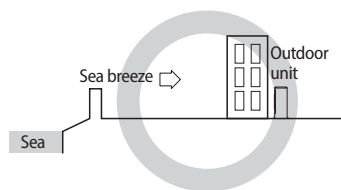

Protection wall should be constructed with a solid material that can block the sea breeze and the height and width of the wall should be 1.5 times larger than the size of the outdoor unit. (You must secure more than 700mm of space between the protection wall and the outdoor unit for air circulation.)



• Depending on the condition of power supply, unstable power or voltage may cause malfunction of the parts or control system. (At a ship or places using power supply from electric generator, etc.)

- ▶ Do not install the Air to Water Heat Pump in following places.
 - A place where there is mineral oil or arsenic acid. There is a chance that parts may get damaged due to burned resin. The capacity of the heat exchanger may reduce or the Air to Water Heat pump may be out of order.
 - The place where corrosive gas such as sulfurous acid gas is vented via the vent pipe or air outlet. The copper may corrode and refrigerant may leak.
 - The place where there is a danger of existing combustible gas, carbon fiber or flammable dust. The place where thinner or gasoline is handled.



• This device must be installed in full compliance to the local electrical codes and regulation like IEC 60364.
 • With an outdoor unit having net weight more than 60kg, we advice not to install it suspended on wall, but considering floor standing installation.

- ▶ If the outdoor unit is installed at a height, ensure that its base is firmly fixed in position.
- ▶ Make sure that the water dripping from the drain hose runs away correctly and safely.
- ▶ When you install the outdoor unit along the side of the road or pavement, you should install it above 2.5m height or make sure that the heat from the outdoor unit shouldn't be in direct contact with passersby. Always comply to local regulations.
- ▶ While in installation or relocation of the product, do not mix the refrigerant with other gases including air or unspecified refrigerant. Failure to do so may cause pressure increase to result in rupture or injury.
- ▶ Do not cut or burn the refrigerant container or pipings.
- ▶ Use clean parts such as manifold gauge, vacuum pump, and charging hose for the refrigerant.
- ▶ Installation must be carried out by qualified personnel for handling the refrigerant. Always, reference the regulations and laws.
- ▶ Be careful not to let foreign substances (lubricating oil, refrigerant other than R-32, water, etc.) enter the pipings.
- ▶ When mechanical ventilation is required, ventilation openings shall be kept clear of obstruction.
- ▶ For disposal of the product, follow the local laws and regulations.
- ▶ Do not work in a confined place.
- ▶ The work area shall be blocked.
- ▶ The refrigerant pipings shall be installed in the position where there are no substances that may result in corrosion.

Installing the unit

- ▶ The following checks shall be performed for installation:
 - The ventilation devices and outlets are operating normally and are not obstructed.
 - Markings and signs on the equipment shall be visible and legible.
- ▶ Upon leakage of the refrigerant, ventilate the room. When the leaked refrigerant is exposed to flame, it may cause generation of toxic gases.
- ▶ Make sure that the work area is safe from flammable substances.
- ▶ To purge air in the refrigerant, be sure to use a vacuum pump.
- ▶ Note that the refrigerant has no odour.
- ▶ The units are not explosion proof so they must be installed with no risk of explosion.
- ▶ This product contains fluorinated gases that contribute to global greenhouse effect. Accordingly, do not vent gases into the atmosphere.
- ▶ For installation with handling the refrigerant(R-32), use dedicated tools and piping materials.
- ▶ Servicing and installation shall be performed as recommended by the manufacturer. In case other skilled persons are joined for servicing, it shall be carried out under supervision of the person who is competent in handling flammable refrigerants.
- ▶ For servicing the units containing flammable refrigerants, safety checks are required to minimise the risk of ignition.
- ▶ Servicing shall be performed following the controlled procedure to minimize the risk of flammable refrigerant or gases.
- ▶ Do not install where there is a risk of combustible gas leakage.
- ▶ Do not install the product near other heat sources.
- ▶ Be cautious not to generate a spark as follows:
 - Do not remove the fuses with power on.
 - Do not disconnect the power plug from the wall outlet with power on.
 - It is recommended to locate the outlet in a high position. Place the cords so that they are not tangled.
- ▶ If the indoor unit is not R-32 compatible, an error signal appears and the unit will not operate.
- ▶ After installation, check for leakage. Toxic gas may be generated and if it comes into contact with an ignition source such as fan heater, stove, and cooker. Please, make sure that only specific refrigerant recovery cylinders are used.
- ▶ Never directly touch any accidental leaking refrigerant.
- ▶ This could result in severe wounds caused by frostbite.

Preparation of fire extinguisher

- ▶ When carrying out welding or brazing on site, ready to use fire extinguishers should be within reach.
- ▶ A dry powder or CO₂ fire extinguisher shall be equipped near the charging area.

Ignition sources free

- ▶ Make sure to store the units in a place without continuously operating ignition sources (for example, open flames, an operating gas appliance or an operating electric heater).
- ▶ The service engineers shall not use any ignition sources with the risk of fire or explosion.
- ▶ Potential ignition sources shall be kept away from the work area where the flammable refrigerant can possibly be released to the surrounding.
- ▶ The work area should be checked to ensure that there are no flammable hazards or ignition risks. The “No Smoking” sign shall be attached.
- ▶ Under no circumstances shall potential sources of ignition be used during leak detection.
- ▶ Make sure that the seals or sealing materials have not degraded.
- ▶ Safe parts are the ones with which the worker can work in a flammable atmosphere. Other parts may result in ignition due to leakage.
- ▶ Replace components only with parts specified by Samsung. Other parts may result in the ignition of refrigerant in the atmosphere from a leak.

Area ventilation

- ▶ Make sure that the work area is well ventilated before performing a hot work.
- ▶ Ventilation shall be made even during the work.
- ▶ The ventilation should safely disperse any released gases and preferably expel them into the atmosphere.
- ▶ Ventilation shall be made even during the work.

Leakage detection methods

- ▶ The leakage detector shall be calibrated in a refrigerant-free area.
- ▶ Make sure that the detector is not a potential source of ignition.
- ▶ The leakage detector shall be set to the LFL (lower flammability limit).
- ▶ The use of detergents containing chlorine shall be avoided for cleaning because the chlorine may react with the refrigerant and corrode the pipings.
- ▶ If leakage is suspected, naked flames shall be removed.
- ▶ If a leakage is found while in brazing, the entire refrigerant shall be recovered from the product or isolated (e.g. using shut-off valves). It shall not be directly released to the environment. Oxygen free nitrogen (OFN) shall be used for purging the system before and during the brazing process.
- ▶ The work area shall be checked with an appropriate refrigerant detector before and during work.
- ▶ Ensure that the leakage detector is appropriate for use with flammable refrigerants.

Installing the unit

Labelling

- ▶ The parts shall be labelled to ensure that they have been decommissioned and emptied of refrigerant.
- ▶ The labels shall be dated.
- ▶ Make sure that the labels are affixed on the system to notify it contains flammable refrigerant.

Recovery

- ▶ When removing refrigerant from the system for servicing or decommissioning, it is recommended to remove the entire refrigerant.
- ▶ When transferring refrigerant into cylinders, make sure that only the refrigerant recovery cylinders are used.
- ▶ All cylinders used for the recovered refrigerant shall be labelled.
- ▶ Cylinders shall be equipped with pressure relief valves and shut-off valves in a proper order.
- ▶ The recovery system shall operate normally according to the specified instructions and shall be suitable for refrigerant recovery.
- ▶ In addition, the calibration scales shall operate normally.
- ▶ Hoses shall be equipped with leak-free disconnect couplings.
- ▶ Before starting the recovery, check for the status of the recovery system and sealing state. Consult the manufacturer if suspected.
- ▶ The recovered refrigerant shall be returned to the supplier in the correct recovery cylinders with the Waste Transfer Note attached.
- ▶ Do not mix refrigerants in the recovery units or cylinders.
- ▶ If compressors or compressor oils are to be removed, make sure that they have been evacuated to the acceptable level to ensure that flammable refrigerant does not remain in the lubricant.
- ▶ The evacuation process shall be performed before sending the compressor to the suppliers.
- ▶ Only the electrical heating to the compressor body is allowed to accelerate the process.
- ▶ Oil shall be drained safely from the system.
- ▶ Never install a motor-driven equipment to prevent ignition.
- ▶ Empty recovery cylinders shall be evacuated and cooled before recovery.

Installation location requirements

- ▶ The outdoor unit shall be installed in an open space that is always ventilated.
- ▶ The local gas regulations shall be observed.
- ▶ For installation inside a building (this applies either to indoor or outdoor units installed inside) a minimum room floor area of space conditioned is mandatory according to IEC 60335-2-40:2018 (see the reference table into either the indoor or outdoor unit installation manual).
- ▶ To handle, purge, and dispose the refrigerant, or break into the refrigerant circuit, the worker should have a certificate from an industry-accredited authority.

Space requirements for outdoor unit

When installing 1 outdoor unit

(Unit : mm)

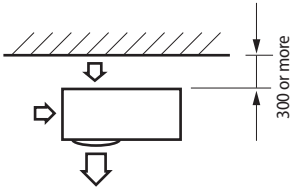

- * When the air outlet is opposite the wall

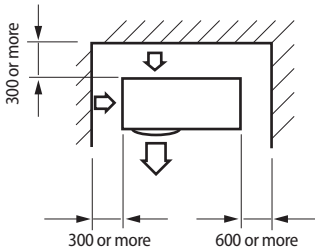

- * When 3 sides of the outdoor unit are blocked by the wall

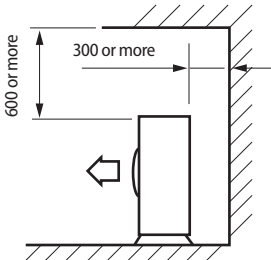

- * The upper part of the outdoor unit and the air outlet is opposite the wall

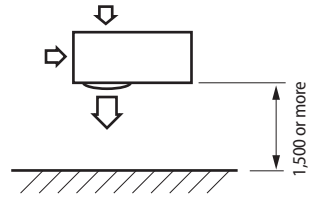

- * When the air outlet is towards the wall

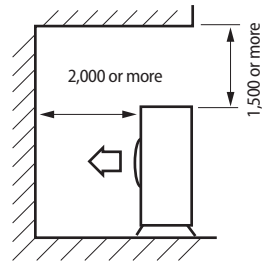

- * The upper part of the outdoor unit and the air outlet is towards the wall

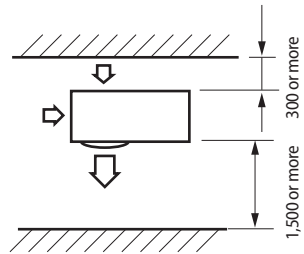

- * When front and rear side of the outdoor unit is towards the wall

Installing the unit

When installing more than 1 outdoor unit

(Unit : mm)

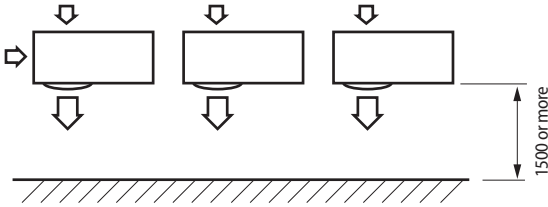

* When the air outlet is towards the wall

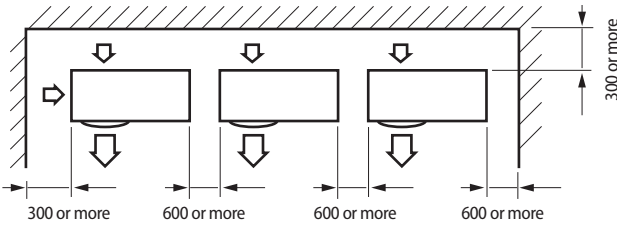

* When 3 sides of the outdoor unit are blocked by the wall

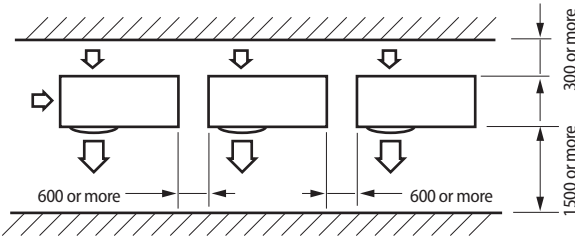

* When front and rear side of the outdoor unit is towards the wall

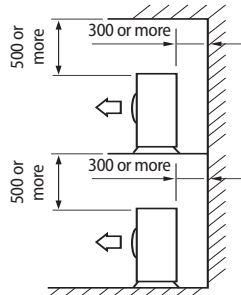

* The upper part of the outdoor unit and the air outlet is opposite the wall

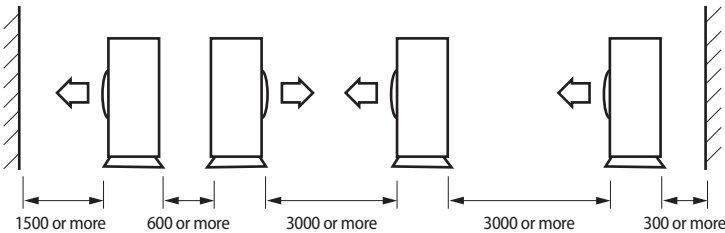

* When front and rear side of the outdoor unit is towards the wall



1. The units must be installed according to distances declared, in order to permit accessibility from each side, either to guarantee correct operation of maintenance or repairing products. The unit's parts must be reachable and removable completely under safety condition (for people or things).

Outdoor unit installation

The outdoor unit must be installed on a rigid and stable base to avoid any increase in the noise level and vibration, particularly if the outdoor unit is to be installed in a location exposed to strong winds or at a height, the unit must be fixed to an appropriate support (wall or ground).

- ▶ Fix the outdoor unit with anchor bolts.



- The anchor bolt must be 20mm or higher from the base surface.



- When tightening the anchor bolt, tighten the rubber washer to prevent the outdoor unit bolt connection part from corroding.
- Make a drain outlet around the base for outdoor unit drainage.
- If the outdoor unit is installed on the roof, you have to check the ceiling strength and waterproof the unit.

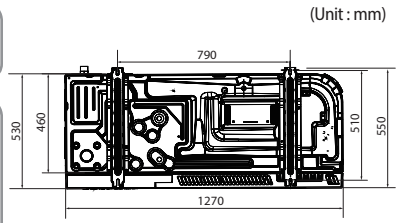

Outdoor unit support

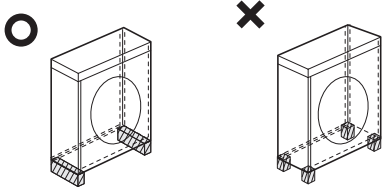

OUTDOOR UNIT INSTALLED ON THE WALL BY RACK

- ▶ Ensure the wall will be able to suspend the weight of rack and outdoor unit ;
- ▶ Install the rack close to the column as much as possible ;
- ▶ Install proper grommet in order to reduce noise and residual vibration transferred by outdoor unit towards wall.



When installing air guide duct

- Check and make sure that screws do not damage the copper pipe.
- Secure air guide duct on guard fan.

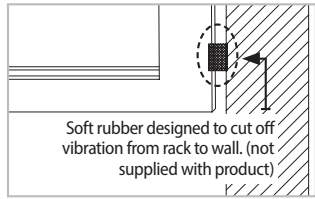
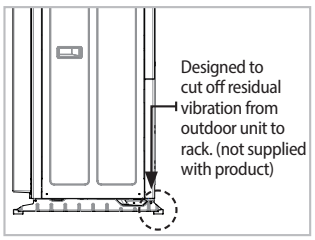
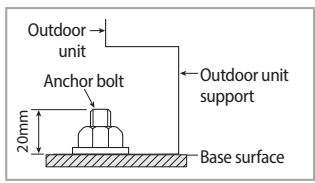

Installing the unit

Drain work

• General area

While Air-Water Heat Pump is running in heating mode, Ice can begin accumulate on the surface of condenser. To prevent Ice from growing, system go into De-frost mode and then Ice on the surface changes to water.

Dropped water from condenser shall be eliminated through running drain holes to prevent Ice growing at low temperature.

- ▶ In case there is not enough space for drainage out of the unit, additional drain works are required. Follow the description as below
 - Install the outdoor unit perfectly level for correct drainage. Provide a minimum of 150mm of free space with the floor. In addition, ensure that the product is located at least 100 mm above the expected level of snow.
 - Insert the drain plug into the hole on the bottom of the outdoor unit.
 - Connect the drain hose to the drain plug.
 - Make sure dirt or small branches do not block the drain hose.
 - Make sure that drain hoses and pipes are not subject to freezing, if needed apply a heater cable (locally sourced).

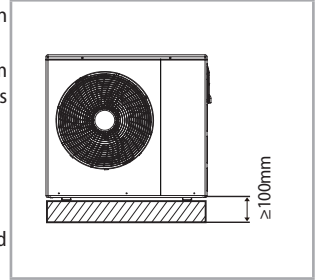

- If drain work is not enough, it can lead to system performance degradation and system damages.

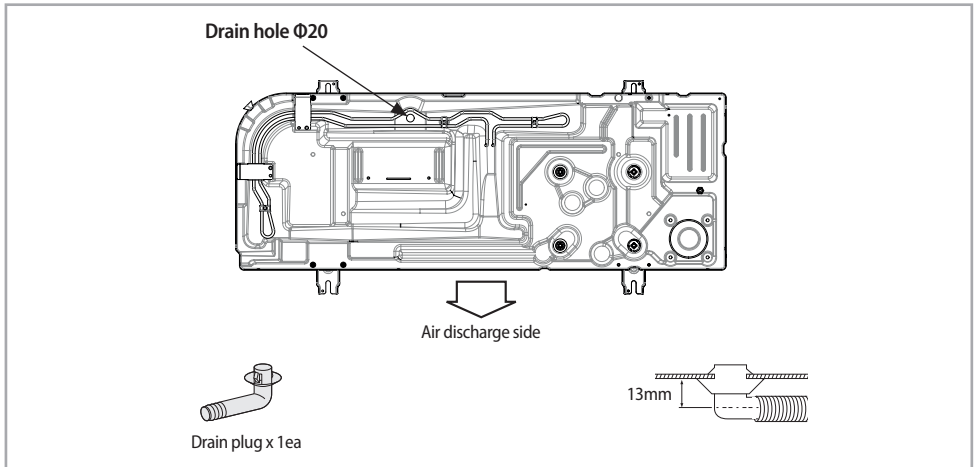

1. Prepare a water drainage channel around the foundation, to drain waste water from around the unit.
2. If the water drainage of the unit is not easy, please build up the unit on a foundation of concrete blocks, etc. (the height of the foundation should be maximum 150 mm).
3. If you install the unit on a frame, please install a waterproof plate within 150 mm of the underside of the unit in order to prevent the invasion of water from the lower direction.
4. When installing the unit in a place frequently exposed to snow, pay special attention to elevate the foundation as high as possible.
5. If you install the unit on a building frame, please install a waterproof plate (field supply) (within 150mm of the underside of the unit) in order to avoid the drain water dripping. (See figure)

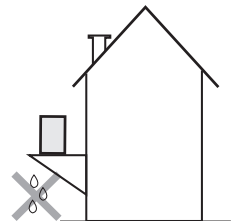

• Heavy snow fall area (Natural drainage)

- ▶ When using outdoor unit in the heating mode, ice may accumulate. During de-icing (defrost operation), the condensed water must be drained off safely. For outdoor unit operates well, you must follow the instructions below.
 - Make space more than 100mm between the bottom of the outdoor unit and the ground for installation.

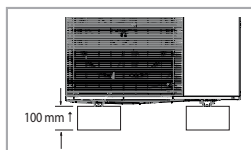

- If the product is installed in a region of heavy snow, allow enough separation distance between the product and the ground.
- When installing the product, make sure that the rack is not placed under the drain hole.
- Ensure that the drained water runs off correctly and safely.



- In areas with heavy snow fall, piled snow could block the air intake. To avoid this incident, install a frame that is higher than estimated snow fall. In addition, install a snow-proof hood to avoid snow from piling on the outdoor unit.
- If ice accumulates on the base, it may cause critical damage to the product. (e.g., a lakeside in a cold area, the seashore, an alpine region, etc.)
- In a heavy snowfall area, do not install the drain plug. And, it may cause frozen ground. Therefore, take appropriate measures to prevent it.

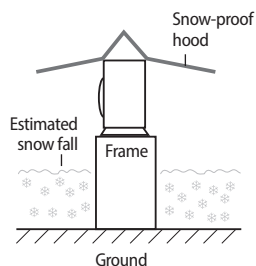

Installing the unit

Selecting a location in cold climates



• When operating the unit in a low outdoor ambient temperature, be sure to follow the instructions described below.

- ▶ To prevent exposure to wind, install the unit with its suction side facing the wall.
- ▶ Never install the unit at a site where the suction side may be exposed directly to wind.
- ▶ To prevent exposure to wind, install a baffle plate on the air discharge side of the unit. (If there is a strong wind facing the outdoor air outlet, it causes a short circuit. This can lead to performance degradation, a fan broken, and acceleration of frost.)
- ▶ In heavy snowfall areas it is very important to select an installation site where the snow will not affect the unit. If lateral snowfall is possible, make sure that the heat exchanger coil is not affected by the snow (If necessary construct a lateral canopy)

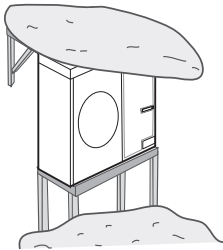

1. Construct a large canopy.
2. Construct a pedestal.
 - Install the unit high enough off the ground to prevent it being buried under snow.

Piping work

Water connections must be made in accordance with the outlook diagram delivered with the unit, respecting the water in- and outlet. If air, moisture or dust gets in the water circuit, problems may occur. Therefore, always take into account the following when connecting the water circuit:

- ▶ Use clean pipes only.
- ▶ Hold the pipe end downwards when removing burrs.
- ▶ Cover the pipe end when inserting it through a wall so that no dust and dirt enter.
- ▶ Use a good thread sealant for the sealing of the connections.
The sealing must be able to withstand the pressures and temperatures of the system.
- ▶ When using non-brass metallic piping, make sure to insulate both materials from each other to prevent galvanic corrosion.
- ▶ Because brass is a soft material, use appropriate tooling for connecting the water circuit. Inappropriate tooling will cause damage to the pipes.

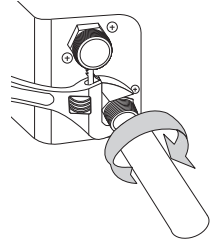

- Be careful not to deform the unit piping by using excessive force when connecting the piping. Deformation of the piping can cause the unit to malfunction.
- Always use two wrenches (spanners) for tightening or loosening the water connections, and tighten connections with a torque wrench as specified in below table. If not, connections and parts can be damaged and leaks.
- The unit is only to be used in a closed water system. If applications are in open water circuit, it will generate Heat exchangers fouling, Corrosion, Leak.

	Name	Tightening torque	
1	BSPP1	350~380 kgf·cm	34 ~ 37 N·m

Flushing and air-purging

When filling water, the following start-up procedure should be followed.

1. All system components and pipes must be tested for the presence of leaks.
2. Preparation of a make-up water assembly or flushing unit is recommended for installation and service.
3. Before connecting pipes to the Outdoor Unit, flush water pipes clean to remove contaminants during hours using a flushing unit or tap water pressure if it is adequate (at 2 to 3 bar)
4. Fill water into the Outdoor Unit by opening shut-off & drain valve.
5. Purge the air. (Fill with a flushing unit with sufficient capacity: avoid aerating the water)
6. Circulate for long enough to ensure that all air has been bled from the complete water piping system.



- After installations, commissioning should be performed by qualified representatives. Unless flushing and air-purging works are performed adequately, it might result in malfunctions.



Flushing unit
(or purging cart)

Piping work



Before installing/commissioning the unit, make sure to check the following points :

- The maximum water pressure of the unit is 2.9 bar static pressure.
- The operating range of leaving water temperature is 15~70°C at heating conditions and 5~25°C at cooling conditions.
- The minimum required water flow for operation is 7 liters/min. At all times the required water flow-rates should remain. Otherwise, the unit can stop due to a lack of water.
- Water quality must be according to EN directive 98/83 EC.
- If the unit and the pipes are exposed to freezing temperature, It can cause damage to the hydraulic system. Special care must be taken to prevent freezing of the total water system.
- The unit is designed to be used in a closed-loop system. Do not use any other components which are designed only for an open-loop system.
- Never use Zn-coated parts in the water circuit. Because the internal water circuit of the unit uses copper pipes, excessive corrosion may occur.
- All hydraulic parts including field piping must be insulated to reduce heat loss and condensation.
- It is recommended to install the make-up water assembly to feed small quantities of water to the system automatically, replacing the minor water losses and maintaining the system pressure.
- Drain taps must be provided at all low points of the system to permit complete drainage of the circuit for maintenance use.
- Make sure that the check valves are correctly installed in the system (field supply).
- Flush pipes out with clean water to remove contaminants in pipes during installation.
- The strainer(water filter) must be cleaned after flushing the pipes, and it should be cleaned periodically. Replace strainer when necessary.
- Charging : Charge the water until a pressure of 1.5~2.0bar by using make-up water assembly(Field supply). (The water pressure indicated on the manometer will vary depending on the water temperature)
The nominal water pressure in the system should remain about 1.0 bar at all times to avoid air entering the water system.
- Air purging; Make sure that air should be vented from the system at start-up or after installing/ servicing. The air vent valve must be opened during charging the water (at least 2 turns) in order to remove all air in the circuit, and a make-up water assembly allows water into the system continuously.
- In case that the water piping would be located in a higher position than the air vent of the unit, it is necessary to add an additional one in the highest position of water circuit. The air vent should be located both where water temperatures are the highest and where the height of pipes are the highest.
- Always use materials which are compatible with water used in the system and with the materials used on the indoor unit.
- Select piping diameter in relation to required water flow and available ESP of the pump.
- Use chemical cleaning agents(Begin with acid , finish with alkali).
- Do not operate the system with closed valves because it results in damaging the heat pump.

About freeze protection

To prevent the hydraulic components from freezing, it has a freezing protection function that includes activation of the pump at low temperatures.

However, in case of a power failure, these functions cannot guarantee protection.

To protect water circuit from freezing, any of the following acts shall be performed.

- Add glycol to water. Glycol lowers the freezing point of water.
- Install the anti-freeze valve. The anti-freeze valve discharges water from the system before it freezes.

Freeze protection by glycol

Freeze protection solutions must use propylene glycol with a toxicity rating of Class 1 as listed in Clinical Toxicology of Commercial Products, 5th Edition.



WARNING

- Ethylene glycol is toxic and must not be used in the primary water circuit in case of any cross-contamination the potable circuit.
- If you add glycol to the water, do NOT install anti-freeze valve. Glycol leaking out of the anti-freeze valve.
- When an antifreeze is used depending on the mix rate, a pressure drop, an efficiency and or capacity reduction may occur.



CAUTION

- Due to the presence of glycol, corrosion of the system is possible. Uninhibited glycol will turn acidic under the influence of oxygen. The acidic uninhibited glycol attacks metal surfaces and forms galvanic corrosion cells that cause severe damage to the system
- A glycol with corrosion inhibitors is selected to counteract acids formed by the oxidation of glycols.
- No automotive glycol is used because their corrosion inhibitors have a limited lifetime and contain silicates which can foul or plug the system.
- Galvanized pipes are NOT used in glycol systems since the presence may lead to the precipitation of certain components in the glycol's corrosion inhibitor.

The required concentration of glycol depends on the lowest expected outdoor temperature, and on whether you want to protect the system from bursting or from freezing. To prevent the system from freezing, more glycol is required.

Add glycol according to the table below.

Freezing Points of Propylene Glycol - Water Mixtures		
Percent Propylene Glycol [wt. %]	Freezing Point [°F]	Freezing Point [°C]
0	32	0
10	26	-3
20	20	-7
30	10	-12
36	0	-18
40	-5	-20
43	-10	-23
48	-20	-29

Piping work

Freeze protection by anti-freeze valve



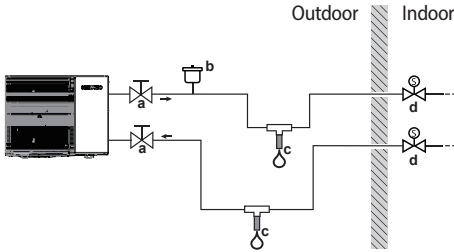

It is the responsibility of the installer to protect the piping against freezing.

When no glycol is added to the water, you can use freeze protection valves at all lowest points of the field piping to drain the water from the system before it can freeze.

To install anti freeze valve



- a Shut off valve (in/out)
- b Air vent
- c Antifreeze valve (Optional - field supply)
- d Normally closed valves (recommend - field supply)

Part	Description
	If necessary, you can close the valve to isolate the water in the outdoor unit.
	Air vent for air purging.
	Protection for the field piping. The antifreeze valve must be installed : <ul style="list-style-type: none"> • Vertically to allow water to flow out properly and free from obstructions. • At all lowest points of the field piping. • In the coldest part and away from heat sources.
	Isolation of water inside the house when there is a power interruption. Normally closed valves (located indoors near the piping entry/exit points) can prevent that all water from indoor piping is drained when the antifreeze valve open. <ul style="list-style-type: none"> • When there is a power interruption: The normally closed valves close and isolate the water inside the house. If the antifreeze valve open, only the water outside the house is drained. • In other circumstances (example: when there is a pump failure): The normally closed valves remain open. If the antifreeze valve open, the water from inside the house is also drained.



CAUTION

- If the system is utilized for both cooling operation (summer), please install freeze protection valves with an ambient air sensor in order to avoid valve opening due to low water temperatures.
- Alternatively set FSV #1012 (minimum cooling set point) 7°C or higher in order to prevent triggering the freeze protection valves during cooling operation.

Setting capacity and pre-pressure of the expansion vessel

When it is required to change the default pre-pressure of the expansion vessel(1 bar), keep in mind the following guidelines:

- ▶ Use only dry nitrogen to set the expansion vessel pre-pressure.
- ▶ Inappropriate setting of the expansion vessel pre-pressure will lead to malfunction of the system. Therefore, the pre-pressure should only be adjusted by a licensed installer.

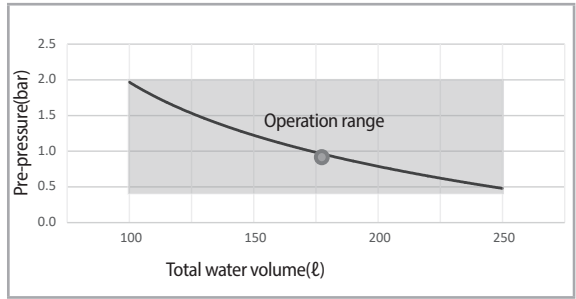

Installation height difference ^(a)	Water volume	
	< 185 Litres	> 185 Litres
<7m	No pre-pressure adjustment required.	Actions required: <ul style="list-style-type: none"> • Pre-pressure must be decreased, calculate according to "Calculating the pre-pressure of the expansion vessel". • Check if the water volume is lower than maximum allowed water volume.
>7m	Actions required: <ul style="list-style-type: none"> • Pre-pressure must be increased, calculate the appropriate value following by "Calculating the pre-pressure of the expansion vessel". • Check if the water volume is lower than maximum allowed water volume. 	Expansion vessel of the unit too small for the installation.

(a) Installation height difference: height difference(m) between the highest point of the water circuit and the indoor unit. If the unit is located at the highest point of the installation, the installation height is considered 0m.

- When Expansion vessel has a capacity 8 liters and 1bar pre-charged.
Water volume of total system for reliable performance is minimum 30 Liter (AE080BXD**), 50 Liter (AE120/140BXD**).

Calculating the pre-pressure of the expansion vessel

- ▶ The pre-pressure(P_g) to be set depends on the maximum installation height difference(H) and is calculated as below :
 $P_g = (H/10 + 0.3)$ bar

Piping work

Unit resistance and PHE resistance by glycol concentrate

The unit is composed of water pipes and PHE basically.

To ensure correct operation and predict the expected performance. Flow and Resistance table can be used and Flow and Resistance characteristic is dependent on Glycol concentration.

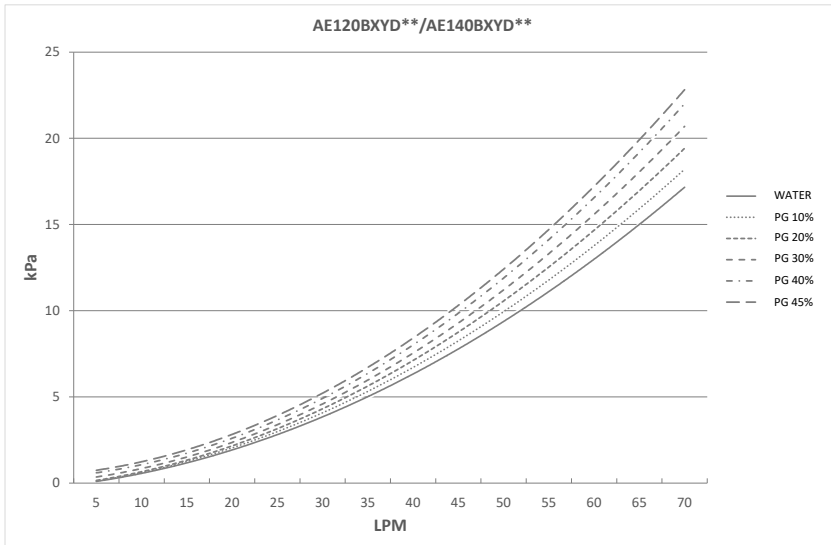
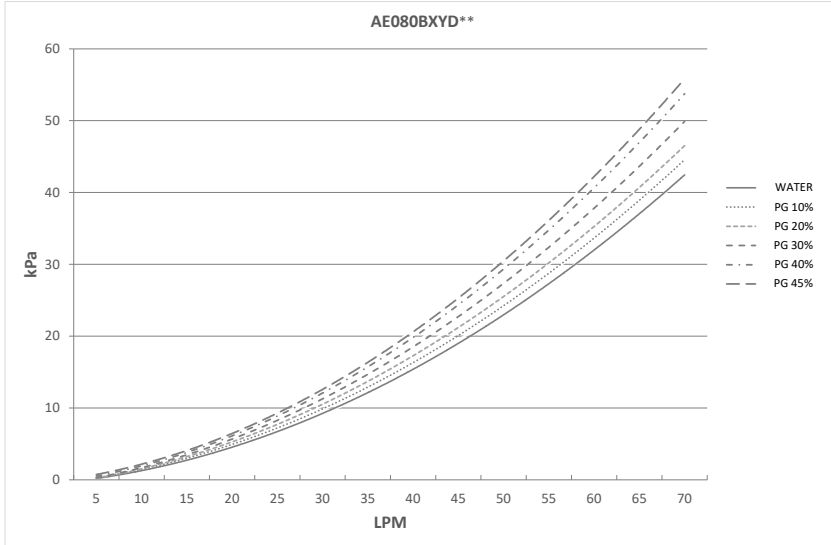

Changing Glycol concentration can cause the pressure drop of the system and it can leads to make flow rate rater slow. Just in case performance degraation, installer shall be careful of flow rate changes.

Flow sensor(at control kit)

Flow sensor is not integrated part in MONO Unit. But the installation is essential to operate the MONO Unit. Flow sensor is provided by Samsung control kit as a sub component.



- Flow sensor shall be installed described by installation manual of Mono unit or Control kit.
- All electric wiring works shall be implemented by manuals which Samsung provided.
- Before completing the installation works, make sure to check if the flow sensor is installed in horizontal or vertical like as below figure.
- If flow direction is in parallel with pipe direction. Straight length of In pipe of flow sensor shall have 10 times length in diameter and Straight length of Out pipe of flow sensor shall have 5 times length in diameter.
- When mechanical vibrations are delivered from the pump or compressor, measurement errors may occur. Select the installation location so that no vibrations are delivered to the sensor.

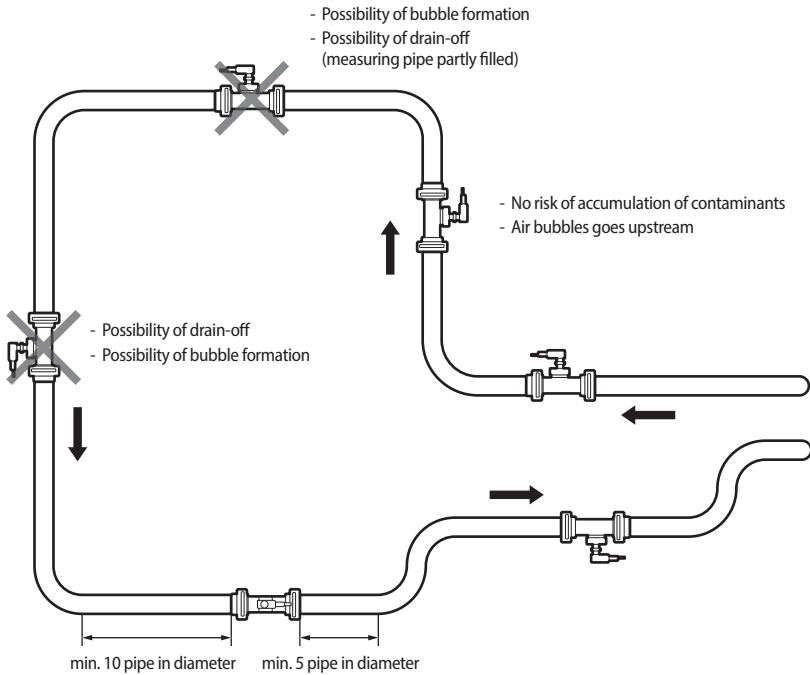

Piping work

Charging water

After installation is completed, the following procedures shall be used to charge water into the Outdoor Unit.

- ▶ Connect water lines to water connections of Air-Water Heat Pump.
- ▶ Air vent valve shall be open at least 2turns so that air can be eliminated in the system.
- ▶ Open the shut-off & drain valve in the water supply connection.
- ▶ Water pressure of supply line shall be over 2.0 bar for good charging work.
- ▶ Stop water supply when the pressure indicates around 2.0 bar.

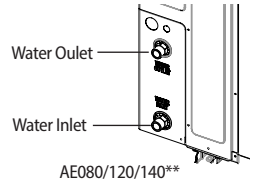

- There shall be enough space for Service works.
- Water pipe and connections shall be cleaned by using water or cleaner before operating the unit at first time.
- Considering E.S.P and water pump performance, select water plumbing specification and under floor loofs.
- Make sure to calculate the total resistance of piping system and determine the size of pipes before selecting the required head of pumps. If the pressure loss of total water system is over than designed pressure, an external water pump shall be installed on piping system in series.
- Do not connect power supply while water is charging.
- When initial installation or re-installation is required, remove air by air vent valve in water plumbings which are installed by local installers to prevent air trap in the system while charging water.
- Make sure that back flow preventer (check valves) shall be installed on main supply line to prevent from contaminating the city water.
 - It is recommended to install the make-up water assembly to prevent from contaminating the city water.
 - Check valves in the make-up water assembly can prevent running water inside Outdoor Unit from contaminating water supplies during installation or maintenance works.

Pressure relief valve

The Mono unit is not equipped with a pressure relief valve, however it is a mandatory protection device in order to prevent abnormal pressure build up by opening at 3.0bar, which could otherwise lead to system damage.



- Make sure that the discharged water does not affect other parts of the installation or electronics. Please utilize a hose to guide the discharged water to the drainage.

Filter / Strainer

Installation of Filter / Strainer is mandatory for the water system. The Filter or Strainer shall be located in front of the inlet pipe of the PHE.

Operating the system without a filter may lead to corrosion, (partial) blockage of the heat exchanger which may lead to system damage, failure or capacity loss.

Filter mesh : #50

Piping insulation

The complete water circuit, inclusive all piping, must be insulated to prevent condensation during cooling operation and reduction of the heating and cooling capacity as well as prevention of freezing of the outside water piping during winter time. The thickness of the sealing materials must be at least 9 mm with (0.035 W/mK) in order to prevent freezing on the outside water piping.

If the temperature is higher than 30°C and the humidity is higher than RH 80%, then the thickness of the sealing materials should be at least 20 mm in order to avoid condensation on the surface of the sealing.

Wiring

Two electronic cables must be connected to the outdoor unit.

- ▶ The communication cable between indoor unit and outdoor unit.
- ▶ The power cable between outdoor unit and auxiliary circuit breaker.
- ▶ Specially for Russian and European market, before installation, the supply authority should be consulted to determine the supply system impedance to ensure compliance.



CAUTION

- During the installation of the unit, firstly make the water circuit connections and secondly the electrical connections. If unit is uninstalled firstly disconnect electrical cables, secondly the water circuit connections.
- Connect the Air to water heat pump to grounding system before performing the electrical connection.
- When installing the unit, you shouldn't use inter connection wire.

Example of EHS system

When using ELB/ELCB for 1 phase (220-240V~)

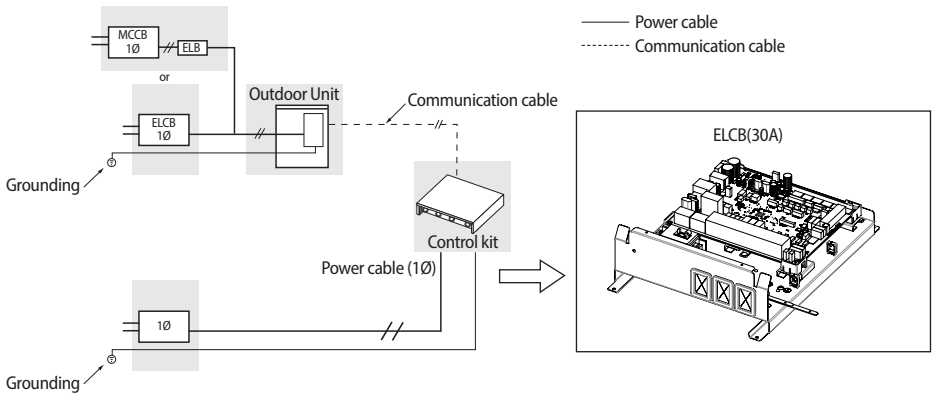

When using ELB/ELCB for 3 phase 4 wires (380-415V~)

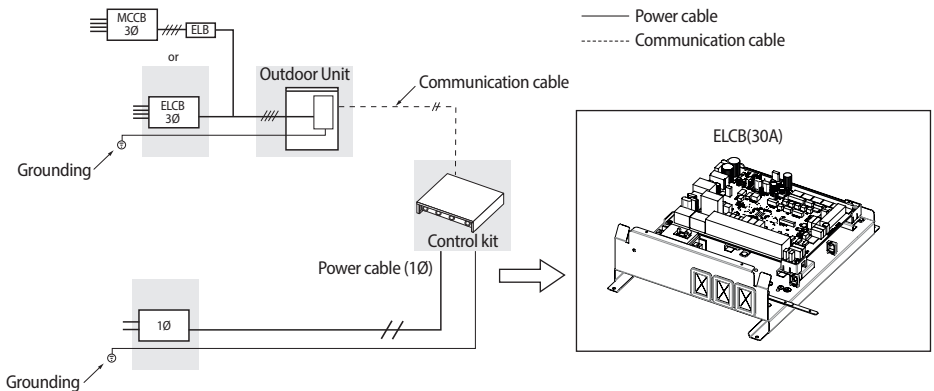

- * For installing protection devices, please follow local electrical regulations (HD-IEC 60364).
- * Installation of control kit must be followed its Installation manual.

Wiring

Power Cable Specifications

1 phase

Outdoor unit	Rated		Voltage Range		MCA	MFA
	Hz	Volts	Min	Max	Min. Circuit Amps.	Max. Fuse Amps.
AE080BXYDEG	50	220-240	198	264	26 A	28.6 A
AE120BXYDEG	50	220-240	198	264	32 A	35.2 A
AE140BXYDEG	50	220-240	198	264	32 A	35.2 A

- ▶ The power cable is not supplied with Air to water heat pump.
- ▶ Supply cords of parts of appliances for outdoor use shall not be lighter than polychloroprene sheathed flexible cord (Code designation IEC:60245 IEC 57 / CENELEC:H05RN-F)
- ▶ This Equipment complies with IEC 61000-3-12.

Indoor Unit	Load	Power supply	Power cable	MAX. length	Type GL 
			mm ² ,wires	m	A
MIM-E03CN MIM-E03EN	No Heater (Water Pump, Valve, Wired RMC)	1Ø, 220-240V, 50Hz	1.5 / 3	<10m	10
			2.5 / 3	10m<L<20m	10
	Booster Heater (3kw)		4.0 / 3	<10m	20
			6.0 / 3	10m<L<20m	20
	Booster Heater (~3kw) + Backup Heater (~3kw)		6.0 / 3	<10m	40
			8.0 / 3	10m<L<20m	40

- ▶ The Power cable is not supplied with the heat pump.
- ▶ For power cable, use the grade H05RN-F materials in 1Ø system.
- ▶ If you connect Backup Heater at separated power cable, you can reduce wire size. (Please refer to control kit installation manual)

3 Phase

Outdoor unit	Rated		Voltage Range		MCA	MFA
	Hz	Volts	Min	Max	Min. Circuit Amps.	Max. Fuse Amps.
AE080BXYDGG	50	380-415	342	457	16.1 A	17.7 A
AE120BXYDGG	50	380-415	342	457	16.1 A	17.7 A
AE140BXYDGG	50	380-415	342	457	16.1 A	17.7 A

- ▶ The power cable is not supplied with air to water heat pump.
- ▶ Supply cords of parts of appliances for outdoor use shall not be lighter than polychloroprene sheathed flexible cord (Code designation IEC:60245 IEC 66 / CENELEC:H07RN-F)
- ▶ This equipment complies with IEC 61000-3-12 provided that the short-circuit power S_{sc} is greater than or equal to 3.3[MVA] at the interface point between the user's supply and the public system. It is the responsibility of the installer or user of the equipment to ensure, by consultation with distribution network operator if necessary, that the equipment is connected only to a supply with a short-circuit power S_{sc} greater than or equal to 3.3[MVA].

Between indoor unit and outdoor unit connection cable specifications(Common in use)

Communication cable	Home server
0.75mm ² , 2wires	0.75mm ² , 2wires

► For the power Cable, use the grade H07RN-F or H05RN-F materials.

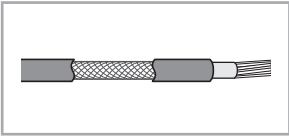

- Power supply cords of parts of appliances for outdoor use shall not be lighter than polychloroprene sheathed flexible cord. (Code designation IEC:60245 IEC 57 / CENELEC: H05RN-F or IEC:60245 IEC 66 / CENELEC: H07RN-F)
- When installing the outdoor unit, use the double shielded (tape aluminium / polyester braid + copper) cable of FROHH2R or LiYCY type.

1-phase terminal block spec

AC power : M5 screw

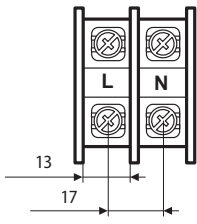

Communication : M4 screw

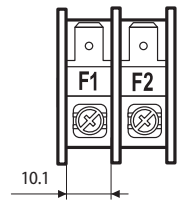

3-phase terminal block spec

AC power : M5 screw

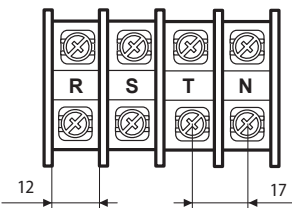

Communication : M4 screw

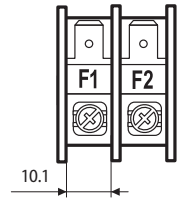

Wiring

Wiring diagram of power cable

When using ELB for 1 phase and 3 phase

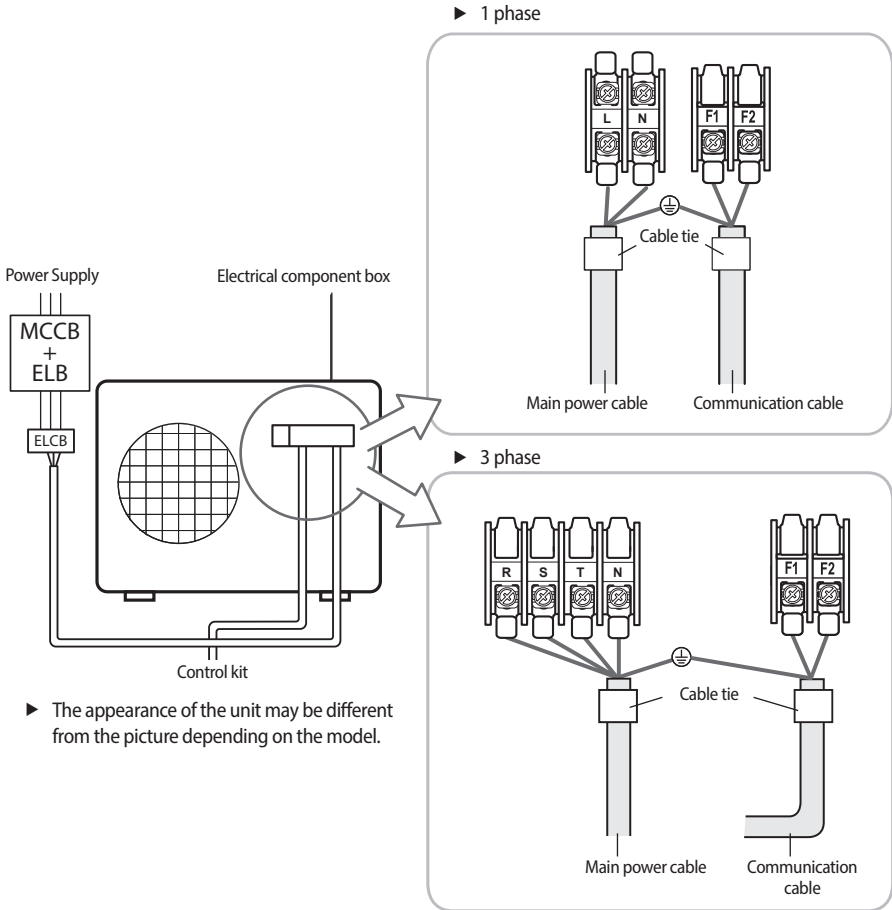

CAUTION

- You should connect the power cable into the power cable terminal and fasten it with a clamp.
- The unbalanced power must be maintained within 2% of supply rating.
 - If the power is unbalanced greatly, it may shorten the life of the condenser. If the unbalanced power is exceeded over 4% of supply rating, the control kit is protected, stopped and the error mode indicates.
- To protect the product from water and possible shock, you should keep the power cable and the connection cord of the control kit and outdoor units within ducts. (with appropriate IP rating and material selection for your application)
- Ensure that main supply connection is made through a switch that disconnects all poles, with contact gap of at least 3 mm.
- Devices disconnected from the power supply should be completely disconnected in the condition of overvoltage category.

Wiring diagram of connection cord

1 phase

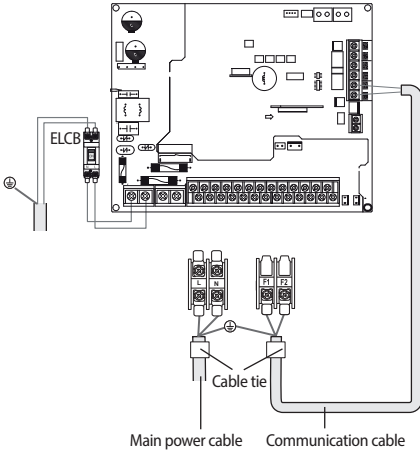

3 phase

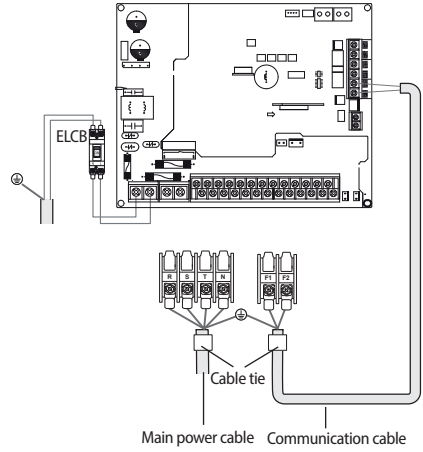

NOTE



- Lay the electrical wiring so that the front cover does not rise up when doing wiring work and attach the front cover securely.
- Ground wire for the indoor unit and outdoor unit connection cable must be clamped to a soft copper tin-plated eyelet terminal with screw hole (NOT SUPPLIED WITH UNIT ACCESSORIES).

Connecting the power terminal

- ▶ Connect the cables to the terminal board using the compressed ring terminal.
- ▶ Cover a solderless ring terminal and a connector part of the power cable and then connect it.

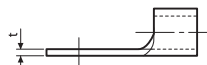
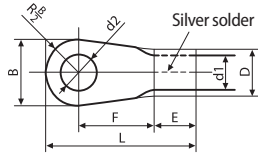

Wiring

Nominal dimensions for cable [mm ² (inch)]		4/6 (0.006/0.009)		10 (0.01)	16 (0.02)	25 (0.03)		35 (0.05)		50 (0.07)	70 (0.10)
Nominal dimensions for screw [mm(inch)]		4 (3/8)	8 (3/16)	8 (3/16)	8 (3/16)	8 (3/16)		8 (3/16)		8 (3/16)	8 (3/16)
B	Standard dimension [mm(inch)]	9.5 (3/8)	15 (9/16)	15 (9/16)	16 (10/16)	12 (1/2)	16.5 (10/16)	16 (10/16)	22 (7/8)	22 (7/8)	24 (1)
	Allowance [mm(inch)]	±0.2 (±0.007)		±0.2 (±0.007)	±0.2 (±0.007)	±0.3 (±0.011)		±0.3 (±0.011)		±0.3 (±0.011)	±0.4 (±0.011)
D	Standard dimension [mm(inch)]	5.6 (1/4)		7.1 (1/4)	9 (3/8)	11.5 (7/16)		13.3 (1/2)		13.5 (1/2)	17.5 (11/16)
	Allowance [mm(inch)]	+0.3 (+0.011) -0.2 (-0.007)		+0.3 (+0.011) -0.2 (-0.007)	+0.3 (+0.011) -0.2 (-0.007)	+0.5 (+0.019) -0.2 (-0.007)		+0.5 (+0.019) -0.2 (-0.007)		+0.5 (+0.019) -0.2 (-0.007)	+0.5 (+0.019) -0.4 (-0.015)
d1	Standard dimension [mm(inch)]	3.4 (1/8)		4.5 (3/16)	5.8 (1/4)	7.7 (5/16)		9.4 (3/8)		11.4 (7/16)	13.3 (1/2)
	Allowance [mm(inch)]	±0.2 (±0.007)		±0.2 (±0.007)	±0.2 (±0.007)	±0.2 (±0.007)		±0.2 (±0.007)		+0.3 (+0.011) -0.2 (-0.007)	±0.4 (±0.015)
E	Min. [mm(inch)]	6 (1/4)		7.9 (5/16)	9.5 (5/16)	11 (3/8)		12.5 (1/2)		17.5 (11/16)	18.5 (3/4)
F	Min. [mm(inch)]	5 (3/16)	9 (3/8)	9 (3/8)	13 (1/2)	15 (5/8)	13 (1/2)	13 (1/2)		14 (9/16)	20 (3/4)
L	Max. [mm(inch)]	20 (3/4)	28.5 (1-1/8)	30 (1-3/16)	33 (1-5/16)	34 (1-3/8)		38 (1-1/2)	43 (1-11/16)	50 (2)	51 (2)
d2	Standard dimension [mm(inch)]	4.3 (3/16)	8.4 (1-3/16)	8.4 (1-3/16)	8.4 (1-3/16)	8.4 (1-3/16)		8.4 (1-3/16)		8.4 (1-3/16)	8.4 (1-3/16)
	Allowance [mm(inch)]	+ 0.2 (+0.007) 0(0)	+0.4 (+0.015) 0(0)	+0.4 (+0.015) 0(0)	+0.4 (+0.015) 0(0)	+0.4 (+0.015) 0(0)		+0.4 (+0.015) 0(0)		+0.4 (+0.015) 0(0)	+0.4 (+0.015) 0(0)
t	Min. [mm(inch)]	0.9 (0.03)		1.15 (0.04)	1.45 (0.05)	1.7 (0.06)		1.8 (0.07)		1.8 (0.07)	2.0 (0.078)

- ▶ Connect the rated cables only.
- ▶ Connect using a driver which is able to apply the rated torque to the screws.
- ▶ If the terminal is loose, fire may occur caused by arc. If the terminal is connected too firmly, the terminal may be damaged.

Tightening Torque (kgf • cm)		
M4		Communication : F1, F2
		3phase AC power : L1(R), L2(S), L3(T), N
M5		1phase AC power : L, N







CAUTION

- When connecting cables, you can connect the cables to the electrical part or connect them through the holes below depending on the spot.
- Run transmission wiring between the indoor and outdoor units through a conduit to protect against external forces, and feed the conduit through the wall together with refrigerant piping.
- Remove all burrs at the edge of the knock-out hole and secure the cable to the outdoor knock-out using lining and bushing with an electrical insulation such as rubber and so on.
- Must keep the cable in a protection tube.
- When the cables are connected through the hole, remove the Plate bottom.

How to connect your extended power cables

1. Prepare the following tools.

Tools	Crimping pliers	Connection sleeve (mm)	Insulation tape	Contraction tube (mm)
Spec	MH-14	20xØ6.5 (HxOD)	Width 19 mm	70xØ8.0 (LxOD)
Shape				

2. As shown in the figure, peel off the shields from the rubber and wire of the power cable.

- Peel off 20 mm of cable shields from the pre-installed tube.

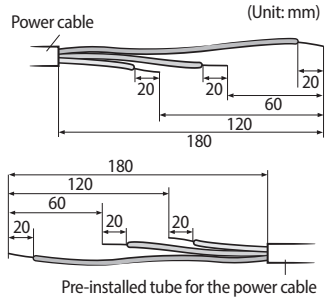

- For information about the power cable specifications for indoor and outdoor units, refer to the installation manual.
- After peeling off cable wires from the pre-installed tube, insert a contraction tube.

3. Insert both sides of core wire of the power cable into the connection sleeve.

► **Method 1**

Push the core wire into the sleeve from both sides.

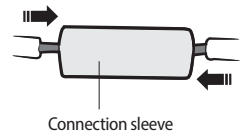

► **Method 2**

Twist the wire cores together and push it into the sleeve.

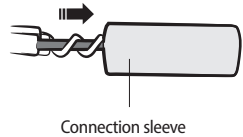

- If cable wires are connected without using connecting sleeves, their contact area becomes reduced, or corrosion develops on the outer surfaces of the wires (copper wires) over a long time. This may cause an increase of resistance (reduction of passing current) and consequently may result in a fire.

4. Using a crimping tool, compress the two points and flip it over and compress another two points in the same location.

- The compression dimension should be 8.0.

- After compressing it, pull both sides of the wire to make sure it is firmly pressed.

► **Method 1**

Compress it 4 times.

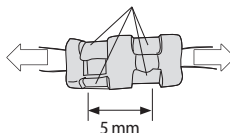

► **Method 2**

Compress it 4 times.

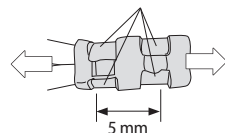

Wiring

5. Apply heat to the contraction tube to contract it.

► **Method 1**

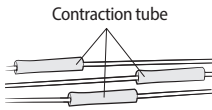

► **Method 2**

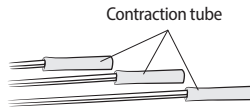

6. Wrap it with the insulation tape twice or more and position your contraction tube in the middle of the insulation tape.

► **Method 1**

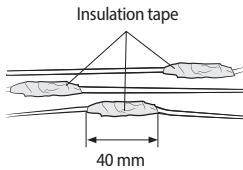

► **Method 2**

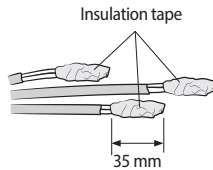

7. After tube contraction work is completed, wrap it with the insulation tape to finish. Three or more layers of insulation are required.

► **Method 1**

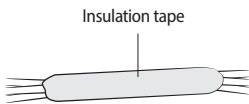

► **Method 2**

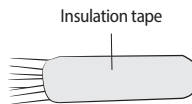

CAUTION

- Make sure that the connection parts are not exposed to outside.
- Be sure to use insulation tape and a contraction tube made of approved reinforced insulating materials that have the same level of withstand voltage with the power cable. (Comply with the local regulations on extensions.)



WARNING

- In case of extending the electric wire, please DO NOT use a round-shaped Pressing socket.
 - Incomplete wire connections can cause electric shock or a fire.

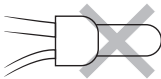

Testing operations

- Check the power supply between the outdoor unit and the auxiliary circuit breaker.
 - 1 phase power supply : L, N
 - 3 phases power supply : R,S,T,N
- Check the CONTROL KIT
 - Check that you have connected the power and communication cables correctly. (If the power cable and communication cables one mixed up or connected incorrectly, the PCB will be damaged.)
 - Check the temp. sensor, drain pump/hose, and display are connected correctly.
- Press K1 or K2 on the outdoor unit PCB to run the test mode and stop.

K1 (Number of Press)	KEY operation	7-segment display
1 time	Trial operation in Heating mode	"K" "1" "BLANK" "BLANK"
2 times	Vacuuming (Outdoor unit address 1)	"K" "2" "BLANK" "1"
3 times	Inverter Fault Detection (Comp #1)	"K" "3" "1" "1"
4 times	End Key operation	-

K2 (Number of Press)	KEY operation	7-segment display
1 time	Trial operation in Cooling mode	"K" "4" "BLANK" "BLANK"
2 times	Discharge mode of DC link voltage	"K" "5" "0" "k" (1phase) "K" "5" "n" "A" (3phase)
3 times	Forced defrost operation	"K" "6" "BLANK" "BLANK"
4 times	Inverter compressor 1 check	"K" "7" "BLANK" "BLANK"
5 times	End Key operation	-

K3 (Number of Press)	KEY operation	7-segment display
1 time	Intialize (Reset) setting	Same as initial state

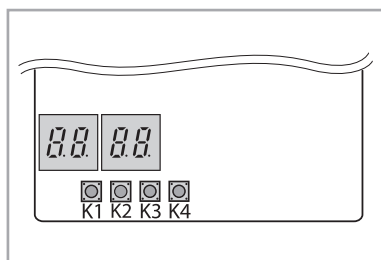
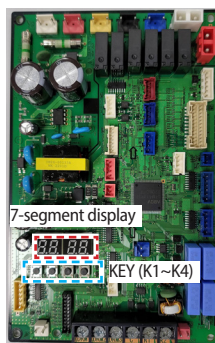

- View Mode : When the K4 switch is pressed, you can see information about our system state as below.

K4 (Number of press)	KEY operation	Display on segment	
		SEG 1	SEG 2,3,4
1 time	Capacity of outdoor unit	1	16HP → 0,1,6
2 times	Order frequency of the compressor	2	120Hz → 1,2,0
3 times	High pressrue (kg/cm ²)	3	15.2K → 152
4 times	Low pressrue (kg/cm ²)	4	4.3K → 043
5 times	Discharge temperature Compressor	5	87°C → 087
6 times	IPM temperature	6	87°C → 087
7 times	CT sensor value	7	2A → 020
8 times	Suction temperature	8	-42°C → -42

Testing operations

K4 (Number of press)	KEY operation	Display on segment	
		SEG 1	SEG 2,3,4
9 times	COND OUT temperature	9	-42°C → -42
10 times	EVA in temperature	A	87°C → 087
11 times	Compressor top temperature	B	87°C → 087
12 times	Outdoor temperature	C	-42°C → -42
13 times	EVI inlet temperature	D	-42°C → -42
14 times	EVI outlet temperature	E	-42°C → -42
15 times	Main EEV step	F	2000 → 200
16 times	EVI EEV step	G	300 → 300
17 times	Fan step (ssr or bldc)	H	13Step → 0,1,3
18 times	Current frequency Compressor	I	120Hz → 1,2,0
19 times	EVI SOL EEV step	J	300 → 300
20 times	Inverter pump output	K	100% → 100

K4 (Number of press) Press and hold the K4 to enter the setting	Displayed content	Display on segment		
		Page 1	Page 2	
1 time	Main version	MAIN	Version (ex. 1412)	
2 times	Inverter version	INV	Version (ex. 1412)	
3 times	EEP version	EEP	Version (ex. 1412)	
4 times	Automatically assigned address of the units	AUTO	SEG1,2	SEG3,4
			Indoor unit: "A", "0" MCU: "C", "1"	Address (ex:07)
5 times	Manually assigned address of the units	MANU	SEG1,2	SEG3,4
			Indoor unit: "A", "0"	Address (ex:15)

Setting outdoor unit option switch and key function

Installing and setting the option with tact switch and explanation of the functions

Setting the option

1. Press and hold K2 to enter the option setting. (Only available when the operation is stopped)
 - If you enter the option setting, display will show the following.

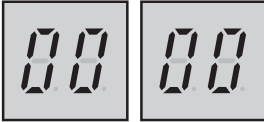

- Seg 1 and Seg 2 will display the number for selected option.
 - Seg 3 and Seg 4 will display the number for set value of the selected option.
2. If you have entered option setting, you can shortly press the K1 switch to adjust the value of the Seg 1, Seg 2 and select the desired option.

Example)

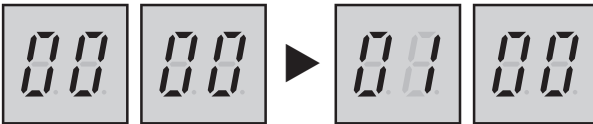

3. If you have selected desired option, you can shortly press the K2 switch to adjust the value of the Seg 3, Seg 4 and change the function for the selected option.

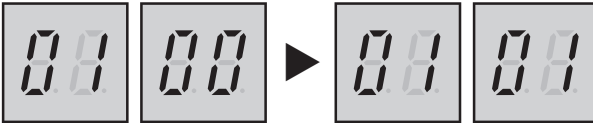

4. After selecting the function for options, press and hold the K2 switch for 2 seconds. Edited value of the option will be saved when entire segments blinks and tracking mode begins.



• Edited option will not be saved if you do not end the option setting as explained in above instruction.

- * While you are setting the option, you may press and hold the K1 button to reset the value to previous setting.
- * If you want to restore the setting to factory default, press and hold the K4 button while you are in the option setting mode.
 - If you press and hold the K4 button, setting will be restored to factory default but it doesn't mean that restored setting is saved. Press and hold the K2 button. When the segments shows that tracking mode is in progress, setting will be saved.

Setting outdoor unit option switch and key function

Key Option

Option	SEG1	SEG2	SEG3	SEG4	Function of the option	Remarks
Current restriction rate	0	0	0	0	100% (Factory default)	When restriction option is set, cooling and heating performance may decrease.
			0	1	95%	
			0	2	90%	
			0	3	85%	
			0	4	80%	
			0	5	75%	
			0	6	70%	
			0	7	65%	
			0	8	60%	
			0	9	55%	
			1	0	50%	
			1	1	No restriction	
Defrost operation	0	1	0	0	Basic	
			0	1	Option	
Fan speed correction for outdoor unit	0	2	0	0	Basic	
			0	1	Option	
Silent mode	0	3	0	0	Low noise (Basic)	
			0	1	Level1	
			0	2	Level2	
			0	3	Level3	
Channel address	0	4	A	U	Automatic setting (Factory default)	Address for classifying the product from upper level controller
			0~15		Manual setting for channel 0~15	
Snow accumulation prevention control	0	5	0	0	Enabled (Factory default)	During snow accumulation, the fan may spin even when the unit is not in operation.
			0	1	Disabled	
Base Heater	0	6	0	0	Disabled	
			0	1	Enabled (Factory default)	
Operation mode	0	7	0	0	Heat pump (Factory default)	
			0	1	Cooling only (Disabled)	
			0	2	Heating only	
Energy saving mode	0	8	0	0	Disabled (Factory default)	
			0	1	Enabled	



WARNING

- Incorrect handling of thermostat, safety valve or other valves may lead to tank rupture. When servicing the unit follow instructions carefully:
 - Always turn off main power supply when water supply is being shut off.
 - Test the free operation of the safety valve regularly by opening the valve ensuring the water flows freely.
 - Electrical connection and all servicing of the electrical components should only be carried out by an authorized electrician.
 - Fitting and all servicing of plumbing fixtures should only be carried out by an authorized installer.
 - When replacing the thermostat, safety valve or any other valve or part supplied with this unit, use only approved parts of the same specification.

Error codes

If the unit has some problems and does not work normally, error code is shown on the OUTDOOR UNIT main PBA or LCD of the wired remote controller.

Display	Explanation	Error Source
108	Setting Address Duplicate Error	OUTDOOR UNIT, CONTROL KIT
120	Zone2 Indoor Room Temperature Sensor Short/Open	CONTROL KIT
121	Error of ROOM Temperature Sensor in Indoor unit short/open	CONTROL KIT
122	Error of Evaporator_in Sensor of Indoor unit short/open	CONTROL KIT
123	Error of Evaporator_out Sensor of Indoor unit short/open	CONTROL KIT
162	Outdoor UNIT EEPROM Error	OUTDOOR UNIT
163	EEPROM OPTION SETTING Error	OUTDOOR UNIT
177	In hydro box, take place emergency signal Error	CONTROL KIT
201	CONTROL KIT / Outdoor UNIT Communication Error (Matching Error)	OUTDOOR UNIT
202	CONTROL KIT / Outdoor UNIT Communication Error	OUTDOOR UNIT
205	Communication Error Between Outdoor Unit Inv Micom - Fan Motor Micom	OUTDOOR UNIT
221	Outdoor Temperature Sensor Error(open/short)	OUTDOOR UNIT
231	COND_OUT Main Temperature Sensor Error (open/short)	OUTDOOR UNIT
241	COND OUT Sensor of Outdoor Unit breakaway Error	OUTDOOR UNIT
251	Discharge Temperature Sensor Error (open/short)	OUTDOOR UNIT
262	Discharge Sensor breakaway Error	OUTDOOR UNIT
266	Comp Top Sensor breakaway Error	OUTDOOR UNIT
269	SUCTION Sensor breakaway Error	OUTDOOR UNIT
276	Compressor Top Temperature Sensor Error (open/short)	OUTDOOR UNIT
291	High Pressure Sensor Error (open/short)	OUTDOOR UNIT
296	Low Pressure Sensor Error (open/short)	OUTDOOR UNIT
308	Suction Sensor Error (open/short)	OUTDOOR UNIT
321	EVI Inlet Sensor Error (open/short)	OUTDOOR UNIT
322	EVI Outlet Sensor Error (open/short)	OUTDOOR UNIT
403	Protect for Freezing Control Error	OUTDOOR UNIT
407	COMP down due to High PressureSensor Protection Control	OUTDOOR UNIT
410	COMP down due to Low PressureSensor Protection Control	OUTDOOR UNIT
416	Comp down due to discharge Temperature	OUTDOOR UNIT
425	Outdoor Reverse Phase or Missing Phase Detect Error	OUTDOOR UNIT
428	COMP down by Compression Ratio control Error	OUTDOOR UNIT
436	Protect for Freezing Burst Control Error	OUTDOOR UNIT

Error codes

Display	Explanation	Error Source
438	EVI EEV Opening Error	OUTDOOR UNIT
439	Refrigerant Leakage Error (Detect when the system is not operated)	OUTDOOR UNIT
440	Forbid Heat mode Operation when Outdoor Temperature is over 43°C	OUTDOOR UNIT
441	Forbid Cooling Mode when Outdoor Temperature is Low 10°C	OUTDOOR UNIT
443	No startup due to Low pressure	OUTDOOR UNIT
458	Outdoor unit Fan Error	OUTDOOR UNIT
461	[Inverter] COMP Operating failure	OUTDOOR UNIT
462	All currency control COMP Stop Or CT2 Low currency	OUTDOOR UNIT
464	[Inverter] DC peak Error	OUTDOOR UNIT
465	Compressor V limit Error	OUTDOOR UNIT
466	[Inverter] DC-Link voltage under/over Error	OUTDOOR UNIT
467	COMP Revolute Error	OUTDOOR UNIT
468	[Inverter] Comp Current Sensor Error	OUTDOOR UNIT
469	DC Link Sensor Error	OUTDOOR UNIT
471	Outdoor unit EEPROM Read/Write Error(OTP error)	OUTDOOR UNIT
474	[Inverter] IPM Heat Sink Error	OUTDOOR UNIT
475	Outdoor unit BLDC Fan Error	OUTDOOR UNIT
483	H/W DC_link over voltage Error	OUTDOOR UNIT
484	PFC Overload Error	OUTDOOR UNIT
485	[Inverter] Input Current Sensor Error (open/short)	OUTDOOR UNIT
488	AC Input Voltage Sensor Error	OUTDOOR UNIT
500	IPM Overheat Error for Inverter COMP	OUTDOOR UNIT
507	Comp Down due to high pressure or High Pressure Switch Open	OUTDOOR UNIT
563	INDOOR UNIT Mixed Install Error	OUTDOOR UNIT
590	[Inverter] Data flash Error	OUTDOOR UNIT
899	Zone1 Tw Temperature Sensor Short/Open	CONTROL KIT
900	Zone2 Tw Temperature Sensor Short/Open	CONTROL KIT
901	Water Inlet Sensor Error (open/short)	OUTDOOR UNIT
902	Water Outlet Sensor Error (open/short)	OUTDOOR UNIT
904	Water TANK Sensor SHORT / OPEN	CONTROL KIT
906	Outdoor EVA in Sensor Error (open/short)	OUTDOOR UNIT
907	Error due to pipe rupture protection	CONTROL KIT
908	Error due to freeze prevention(Re-Operation is possible)	CONTROL KIT

Display	Explanation	Error Source
909	Error due to freeze prevention(Re-Operation is impossible)	CONTROL KIT
910	Water Temperature Sensor on water Outlet pipe is detached	CONTROL KIT
911	FLow Swtich Open Error	CONTROL KIT
912	FLow Swtich Close Error	CONTROL KIT
913	Six times detection for FLOW Switch Error(Re-Operation is not possible)	CONTROL KIT
914	Error due to Incorrect Thermostat Connection	CONTROL KIT
915	Error on DC fan(Non-operating)	CONTROL KIT
916	Mixing Sensor Short/Open	CONTROL KIT
919	Disinfection Operation Incomplete Error	CONTROL KIT

Maintenance

Listed checks and inspections shall be implemented regularly so that the unit can operate as design intention in production site.

Always switch off the unit and remove power cable from the electric source before carrying out any maintenance or repair works.

Mentioned actions shall be carried out at least once a year by qualified personnel.

1. Water pressure
 - Check if the water pressure is above 0.3 bar. If necessary, fill a supplement water.
2. Water filter
 - Use water filter which is available for cleaning and clean it regularly.
3. Water pressure relief valve
 - Check for correct operation of the pressure relief valve.
 - The valve will work over the designated pressure.
 - If there is leakage of water or water splashed in normal condition, please contact your local installer.
4. Glycol
 - Record and check the glycol concentration and the pH-value in the system at least once a year.
 - A Ph-value below 8.0 indicates that a significant portion of the inhibitor has been depleted and that more inhibitor needs to be added.
 - When the Ph-value is below 7.0 then oxidation of the glycol occurred, the system should be drained and flushed thoroughly before severe damage occurs.
 - Make sure that the disposal of the glycol solution is done in accordance with relevant local and national regulation.

Adding refrigerant

The Heat Pump unit is provided to users with the correct amounts of refrigerants as initial setting values. While using the unit or doing refrigerant piping works, there can be some loss of refrigerants compared to initial amounts. To run the units properly, keep the amount of refrigerant which SAMSUNG designated.

Procedures as below is describing how to adding the amount of refrigerant.



WARNING

- R-32 Shall be added as liquid phase.
- Adding and recharging works shall be by Charging Ports.

1. Connect the manifold gauge and purge the manifold gauge.
2. Open the manifold gauge valve of the liquid side Charging Ports and add the liquid refrigerant.
3. If you cannot fully recharge the additional refrigerant while the outdoor unit is stopped, use the key on PCB in the Heat Pump to run for recharging the remaining refrigerant.

Adding refrigerants in running condition

1. Press the function key for adding refrigerant.
2. After 30 minutes of operation, open the Charging Ports on low pressure side in Heat Pump.
3. Open the valve for low pressure side in the manifold gauge to recharge the remaining refrigerant.
4. After completing, close the valves in manifold gauge and eliminate the hoses from Charging Ports.

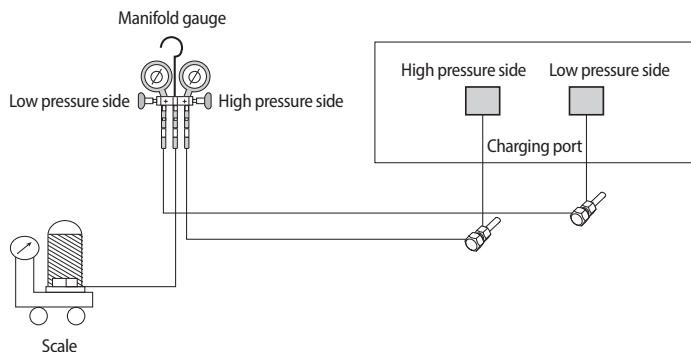

Important information regulation regarding the refrigerant used



- Inform user if system contains 3 kg or more of fluorinated greenhouse gases. In this case, it has to be checked for leakage at least once every 12 months, according to regulation n°842/2006. This activity has to be covered by qualified personnel only. In case situation above (3 kg or more of R-32), installer (or recognised person which has responsibility for final check) has to provide a maintenance book, with all the information recorded according to REGULATION(EC) N° 842/2006 OF THE EUROPEAN PARLIAMENT AND OF THE COUNCIL of 17 May 2006 on certain fluorinated greenhouse gases.



- For the product that uses the R-32 refrigerant, be cautious not to generate a spark by keeping the following requirements:
 - Do not remove the fuses with power on.
 - Do not disconnect the power plug from the wall outlet with power on.
 - It is recommended to locate the outlet in a high position. Place the cords so that they are not tangled.

Precautions on adding the R-32 refrigerant

In addition to the conventional charging procedure, the following requirements shall be kept.

- ▶ Make sure that contamination by other refrigerants does not occur for charging.
- ▶ To minimize the amount of refrigerant, keep the hoses and lines as short as possible.
- ▶ The cylinders shall be kept upright.
- ▶ Make sure that the refrigeration system is earthed before charging.
- ▶ Label the system after charging, if necessary.
- ▶ Extreme care is required not to overcharge the system.
- ▶ Before recharging, the pressure shall be checked with nitrogen blowing.
- ▶ After charging, check for leakage before commissioning.
- ▶ Be sure to check for leakage before leaving the work area.

Maintenance

It is recommended that annually a competent person

- a Inspects and cleans the line strainer.
- b Checks the operation of the expansion relief valve and temperature & pressure relief valve.
- c Recommissions the cylinder in accordance with the instructions.

Tundish

Install the Tundish in a vertical position within a maximum of 600mm from the temperature and Pressure Relief Valve drain connection. Ensure the expansion relief pipework discharges through the tundish. Tundish pipework must be 22mm with a minimum vertical length of 300mm below tundish.

Maximum permitted length of 22mm pipework is 9m. Each bend or elbow is equivalent to 0.8m of pipework.

All pipework must have continuous fall and discharge in a safe, visible position. If any doubt, refer to Building Regulation G3.

Charging refrigerant

- ▶ Measure the quantity of the refrigerant according to the length of the liquid side pipe. Add quantity of the refrigerant using a scale.

Important information: regulation regarding the refrigerant used

This product contains fluorinated greenhouse gases. Do not vent gases into the atmosphere.



- Inform user if the system contains 5 tCO₂e or more of fluorinated greenhouse gases. In this case, it must be checked for leakage at least once every 12 months, according to regulation No. 517/2014. This activity must be covered by qualified personnel only. In the case of the situation above, the installer (or authorized person with responsibility for final check) must provide a maintenance book, with all the information recorded, according to REGULATION (EU) No. 517/2014 OF THE EUROPEAN PARLIAMENT AND OF THE COUNCIL of 16 April 2014 on fluorinated greenhouse gases.

Please fill in the following with indelible ink on the refrigerant charge label supplied with this product and on this manual.

- ▶ ① the factory refrigerant charge of the product.
- ▶ ② the additional refrigerant amount charged in the field.

Unit	kg	tCO ₂ e
①, a		
②, b	DO NOT CHARGE	

Refrigerant type	GWP value
R-32	675

- GWP: Global Warming Potential
- Calculating tCO₂e: kg x GWP/1000



- a Factory refrigerant charge of the product: see unit name plate.
- b Additional refrigerant amount charged in the field. (Refer to the above information for the quantity of refrigerant replenishment.)



- The filled-out label must be adhered in the proximity of the product charging port. (ex. onto the inside of the stop valve cover.)

Troubleshooting

FAULT	POSSIBLE CAUSE	REMEDY
No water flow from hot taps.	<ol style="list-style-type: none"> 1. Mains supply off. 2. Strainer blocked. 3. Cold water inlet Pressure Reducing Valve incorrectly fitted. 	<ol style="list-style-type: none"> 1. Check and open stopcock. 2. Turn off water supply. Remove strainer and clean. 3. Check and refit as required.
Water from hot taps is cold.	<ol style="list-style-type: none"> 1. Immersion heaters not switched on. 2. Immersion heater thermal cut-out has operated. 3. Programmer set to central heating or not switched on. 4. Boiler not working 5. Motorised valve not operating correctly. 	<ol style="list-style-type: none"> 1. Check and switch on. 2. Check and reset button. 3. Check and set to hot water. 4. Check boiler operation. If fault suspected, consult installer or boiler manufacturer. 5. Check wiring and/or plumbing connections to motorized valve.
Intermittent water discharge	<ol style="list-style-type: none"> 1. Reduced internal expansion. 2. Thermal control failure. (Note Water will be hot). 	<ol style="list-style-type: none"> 1. Repressurize expansion vessel. Follow cold water discharge. 2. Switch off power to immersion heater(s) and boiler supply to the unit. When discharge has stopped, check thermal controls, replace it faulty. Contact a competent person.
Continuous water discharge	<ol style="list-style-type: none"> 1. Cold water inlet Pressure Reducing Valve not working 2. Temperature and pressure relief valve faulty. 3. Expansion relief valve not working correctly. 	<ol style="list-style-type: none"> 1. Check pressure from valve if greater than 2.1 bar replace. 2. As No2 of above. 3. Check and replace if faulty.
Room thermostat does not switch on or not work properly	Wireless room thermostat batteries not Working	Replace new batteries for wireless room thermostat



NOTE

• Disconnect electrical supply before removing any electrical equipment covers.

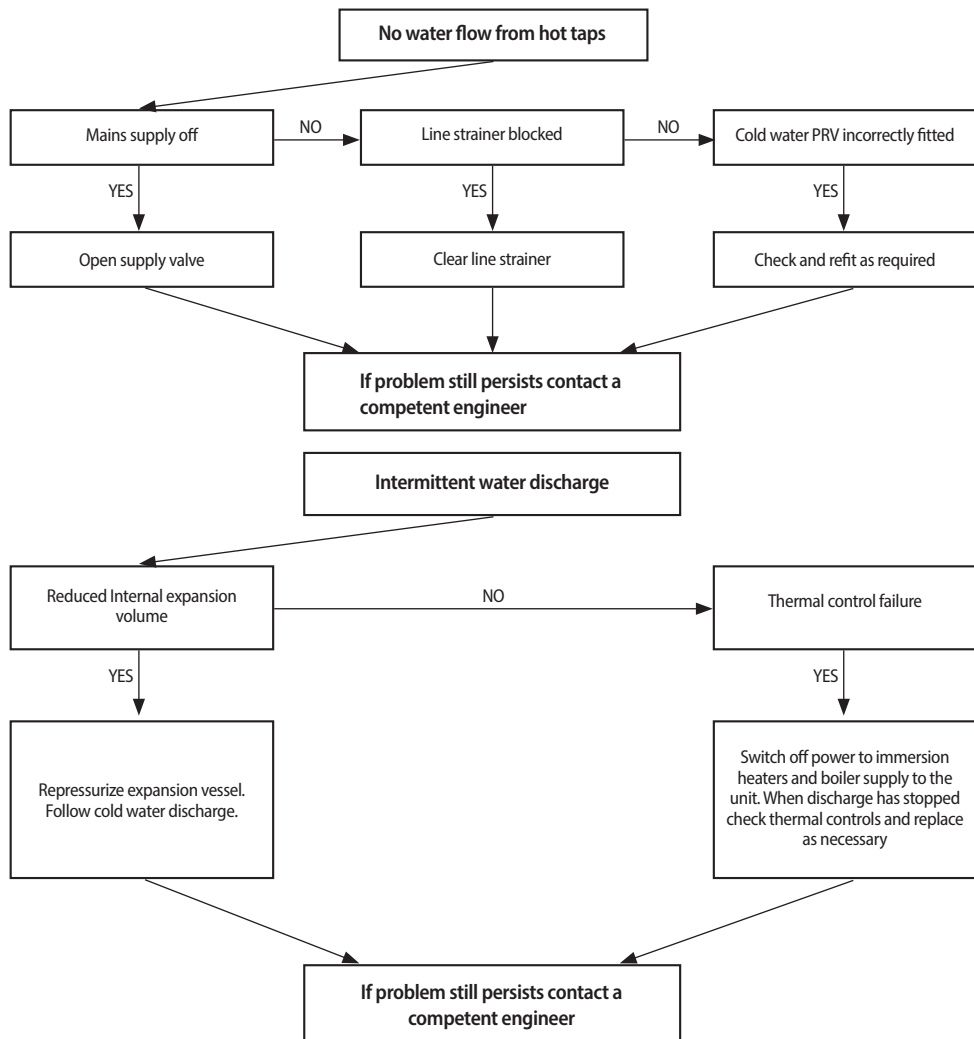

Troubleshooting

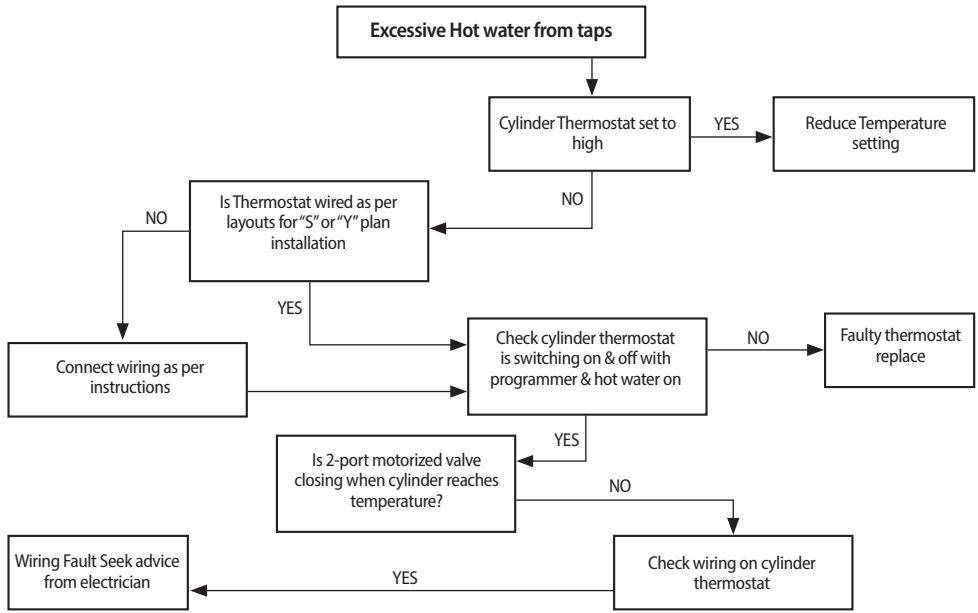
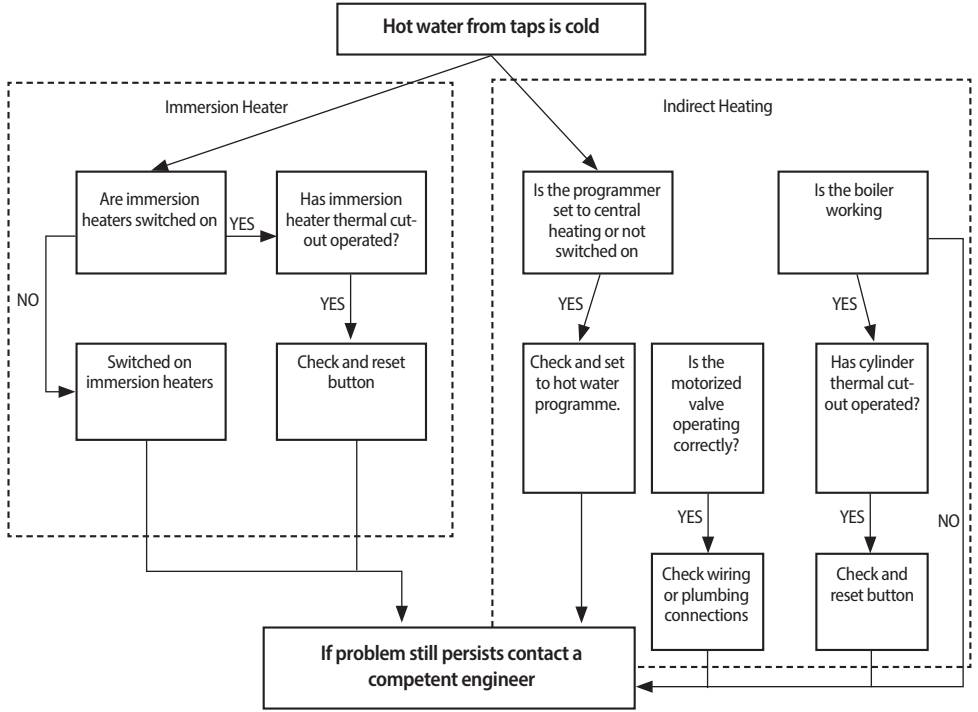

If in doubt at any stage you must consult a qualified technician

Commissioning

Filling up

1. Open a hot tap.
2. Open the cold water supply valve.
3. When water flows from hot tap, close the tap.
4. Allow the system to stabilize for 5 minutes.
5. Open each hot water tap in turn to expel air from the system pipe work.
6. Check for leaks.
7. Manually operate Temperature and Pressure Relief Valve to ensure free water flow through discharge pipe. (Turn knob to left.)

Draining/flushing

1. Turn off mains supply.
2. Connect hose pipe to drain cock at base of cylinder.
3. Open hot tap. Open drain valve and open temperature & pressure relief valve.
4. Allow to drain. Follow commissioning instructions (above) to refill.

Recommissioning instructions

Cold or tepid water discharge from tundish - The tundish should be installed away from electrical devices.

1. Close cold water supply valve.
2. Open a hot tap.
3. Repressurise the expansion vessel air charge to its set level.
4. Close hot tap.
5. Open the cold water supply valve.

Hot water discharge from tundish

This indicates a malfunction of a thermal cut-out, operating thermostat or the combined temperature and pressure relief valve. Turn off the electrical supply to the immersion heater and also isolate an indirect unit from the boiler. Contact the installer or competent engineer.



This appliance is filled with R-32.